

Acerbis

Acerbis

Acerbis

Acerbis

Catalogo Collezione

Collection Catalogue

Acerbis



<b>Un secolo e mezzo di storia</b>	<b>A Century and a half of history</b>	<b>4</b>
<b>Indice</b>	<b>Index</b>	<b>19</b>
<b>Remasters</b>	<b>Remasters</b>	
	Creso	54
	Florian	79
	Gong	72
	Jot	32
	Life sofa	67
	Life system	88
	Maestro	36
	Med	42
	Menhir	26
	Serenissimo	48
	Sheraton	20
	Spiros	85
	Storet	60
<b>Collection</b>	<b>Collection</b>	
	Alterego	92
	Alterego Low	96
	Axis	101
	Ghostwriter	105
	Grand Buffet	108
	Judd	113
	Litt	115
	Ludwig	116
	Maxwell	121
	Moodboard	125
	Moodboard Console	129
	NC Sideboard	132
	Outline	135
	Pond	139
	Steel	143
<b>Informazioni tecniche</b>	<b>Technical information</b>	<b>146</b>

## IT Un secolo e mezzo di storia

Tra le più longeve aziende italiane nel settore dell'arredamento, Acerbis è un punto di riferimento per gli estimatori del design italiano. All'avanguardia con i suoi 150 anni di esperienza, la sua costante ricerca di modernità ha prodotto creazioni di straordinaria innovazione. Originariamente con sede nella Valle Seriana della bergamasca, in quell'area nel nord della Lombardia votata all'industria del mobile che ha reso Milano la capitale mondiale del design, Acerbis è passata di padre in figlio fino ad oggi, alla sua quarta generazione, che vede Enrico Acerbis come nuovo ambasciatore del marchio.

## EN A Century and a half of history

One of the most enduring furniture companies in Italy, Acerbis stands as a connoisseur's benchmark of Italian design – a pioneer with 150 years of expertise, whose continual search for modernity has produced creations of stunning innovation. Originally located in Bergamo's Valle Seriana, part of the northern furniture – making hub of Lombardy that transformed Milan into the world's design capital – Acerbis has passed from fathers to sons through the decades and is now in its fourth generation with Enrico Acerbis as the brand's ambassador.



FABBRICA MOBILIA MOTORE ELETTRICO TAPPEZZIERE - FALGNERIA - CARPENTIERE IMPIANTI COMPLETI		
Benvenuto Acerbis Piazza Spini - ALBINO - Piazza Spini		
Sig. Lucrezio Segni, all'abitato dei Signori Ungger Albino		
Piano terreno		
1	Porta grande d'entrata	120,00
2	Porte laterali	120
11	Antipiani L. 50 a 3 grandi ripide unito al piano	330
1	Antipiani L. 50 a 3 " " " " " " " " " " " "	120
1	Antipiani sala soggiorno un ripido sopra un ripido unito al ripido di un antipiano tanto sotto come sopra	60
1	Antipiani sala bagno ripido unito al ripido in un'ala	24
1	Antipiani per balcone un ripido sopra al ripido in un'ala	30
2	Antipiani per armadio a 3 ripidi	25
1	Antipiani sotto scala con ripido unito al ripido in un'ala	25
6	Compartimenti per armadi	125
2	Soffitti a modanatura	125
11	Soffitti per antipiani	2,00
8	Scala per piano a 2 antipiani in lamiera e pannello	25
	di impiego	2,00
	Spese un'auto per portare tutto l'impianto	9
		22

1 Lodovico Acerbis gioca nella falegnameria paterna ad Albino, Bergamo.  
2 1870, Benvenuto Acerbis fondatore.  
3 Fattura primi del '900.

## IT La rivoluzione di Lodovico Acerbis

Fondata nel 1870 da Benvenuto Acerbis, un sapiente artigiano del legno che seppe creare una solida clientela grazie ai suoi design artigianali personalizzati, l'azienda si è evoluta, mantenendo sempre una solida conduzione familiare, dall'iniziale lavorazione artigianale alla produzione in serie con l'avvento di Lodovico Acerbis negli anni '60, epoca caratterizzata dalle collaborazioni con alcuni dei più innovativi designer italiani e internazionali – per citarne alcuni, Massimo e Lella Vignelli, Vico Magistretti, Nanda Vigo, Gianfranco Frattini, Giotto Stoppino, Mario Bellini e Andrea Branzi.

Acerbis è una delle poche aziende italiane ad aver preso parte alle prime edizioni del Salone del Mobile di Milano, partecipandovi per la prima volta nel 1965, e ad aver presentato da allora nuovi design in ogni edizione della fiera.

## EN Lodovico Acerbis' revolution

Founded in 1870 by Benvenuto Acerbis, a skilled woodworker who built up a loyal clientele for his artisanal custom designs, Acerbis has seen its family leadership guide the company from early craft fabrication to Lodovico Acerbis' 1960s-era leap to serial production and collaborations with some of Italy's most trailblazing designers – among them, Massimo and Lella Vignelli, Vico Magistretti, Nanda Vigo, Gianfranco Frattini, Giotto Stoppino, Mario Bellini, and Andrea Branzi.

The brand is one of just a handful of Italian companies to have exhibited at Milan's Salone del Mobile from the very beginning, in 1965, and to present new designs at each edition ever since.

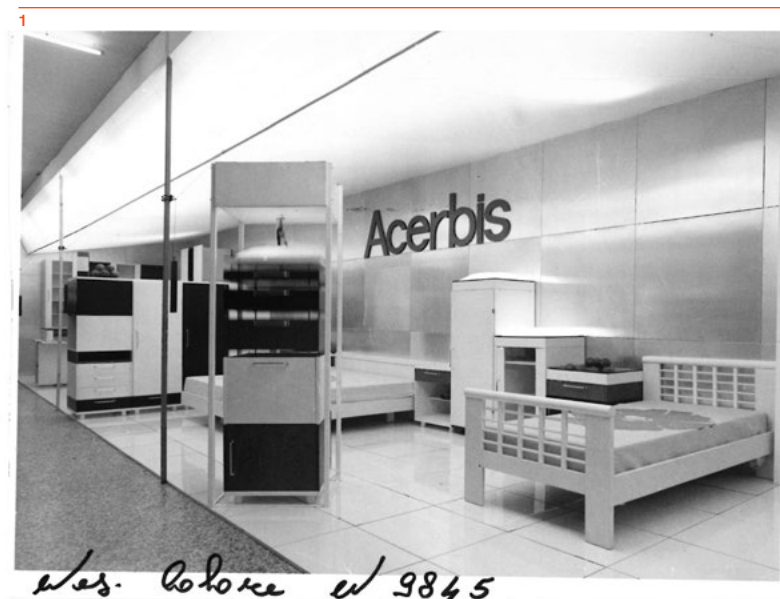

1 1968, presentazione Addition System, Lomazzo, Urbino e De Pas.  
2 1976, primo monomarca Acerbis in piazza del Duomo, Milano.

1 Lodovico Acerbis plays in his father's carpentry workshop in Albino, Bergamo.  
2 1870, Benvenuto Acerbis, founder.  
3 Early 20th century invoice.

1 1968, Addition System presentation, Lomazzo, Urbino and De Pas.  
2 1976, first Acerbis flagship store in Piazza del Duomo, Milan.

## IT Nuova identità

Il nuovo logo prende spunto dallo studio del monogramma originale “ab” di Acerbis, che si va a semplificare in una “a” diversa ed originale. Una “a” caratterizzata da linee e geometrie importanti, che non la induriscono necessariamente, ma che invece creano una forma gentile e simpatica. Una forma familiare, in quanto ricorda una chiocciola, un nautilus o una proporzione aurea. Il logo rappresenta anche un oblò, un cannocchiale da cui osservare e interpretare il design attraverso la lente di Acerbis. Raffigura anche un graffito, ovvero il segno di un writer nel suo studio del lettering.

Nella ricerca delle forme che meglio interpretassero l'immagine di Acerbis, si è trovato il punto di incontro nello studio di Max Bill. All'inizio degli anni '70, il designer si cimentò nella progettazione di un carattere derivato “dall'immagine delle parole”. Un font che doveva “dare leggibilità automatizzando macchine che enfatizzassero la tonalità delle vocali per aumentare la leggibilità.”

## EN New visual identity

The new logo draws inspiration from the original Acerbis monogram “ab”, reduced to a different, original letter “a”. An “a” characterised by marked lines and shapes that don't necessarily harden it but, rather, create a fun, graceful shape. A familiar shape recalling a snail, a nautilus or a golden ratio. The logo also represents a porthole, a spyglass allowing us to view and interpret design through Acerbis' lens. Last but not least, it also represents graffiti – that is, the mark of a writer who studies lettering.

In studying the shapes that would best convey the Acerbis image, Max Bill's work proved a point of convergence. In the early 1970s, the designer tried his hand at designing a typeface stemming from “the image of words”. A font meant to “ease legibility by automating machines that would enhance the tonalities of vowels to increase their readability”.

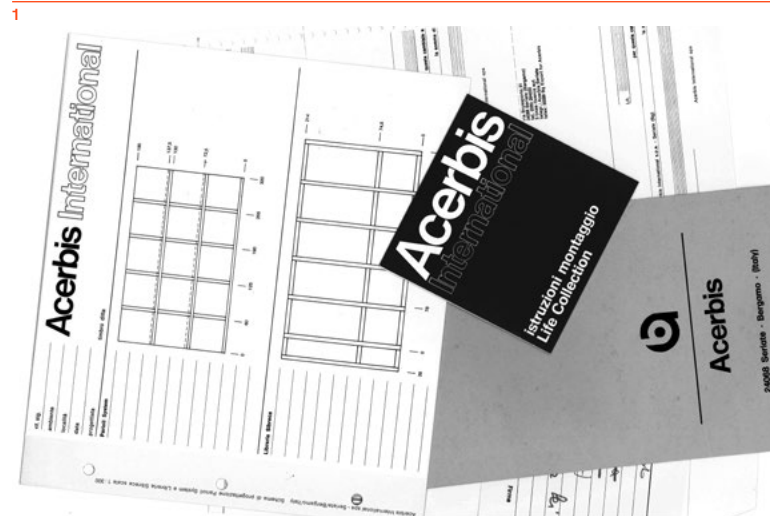

1 Anni 70, documenti di archivio identità grafica.  
2 2021, nuovo marchio e logotipo.

1 1970s, graphic identity archive documents.  
2 2021, new brand identity and logo.

## IT Un rinnovato percorso creativo

Con l'ingresso nel gruppo MDF Italia nel 2019 e la nomina di Francesco Meda e David Lopez Quincoces a nuovi direttori creativi, la missione di Acerbis continua con rinnovato vigore. Grazie alla loro percezione visionaria del contemporaneo e alla passione per la storia del design, i due hanno iniziato questo nuovo percorso esplorando gli archivi Acerbis e riproponendo versioni aggiornate di prodotti storici dell'azienda, la cui modernità rimane all'avanguardia ancora oggi. Ciascun design di archivio è stato scelto accuratamente da Meda e Lopez Quincoces per celebrare un'epoca leggendaria di sperimentazione e per fornire un'analisi prospettica delle icone Acerbis: vere fondamenta di bellezza e funzionalità, radicate nella potente tradizione di questo marchio, presupposti su cui costruire i futuri capitoli della storia di Acerbis.

## EN A new creative course

With the entry in the MDF Italia group in 2019 and the newly appointed creative directors Francesco Meda and David Lopez Quincoces, Acerbis's mission continues with fresh vigor. Thanks to their visionary sense of the contemporary and passion for the history of design, the pair have commenced a reawakening of Acerbis' archives, relaunching fresh versions of creations whose modernity remains progressive even today. Each archive design was carefully chosen by Meda and Lopez Quincoces to highlight an era of iconic experimentation, and to create a forward-looking survey of Acerbis' beautifully useful icons: a foundation grounded in the potent heritage of this pace-setting brand to commence a new chapter of Acerbis.



1 Francesco Meda, David Lopez Quincoces.  
2 1985, Serenissimo copertina Interni 356.  
3 1979, Sheraton compasso d'Oro ADI.  
4 1985, Serenissimo copertina Modo 84.

1 Francesco Meda, David Lopez Quincoces.  
2 1985, Serenissimo featured on Interni 365 cover.  
3 1979, Sheraton compasso d'Oro ADI.  
4 1985, Serenissimo featured on Modo 84 cover.

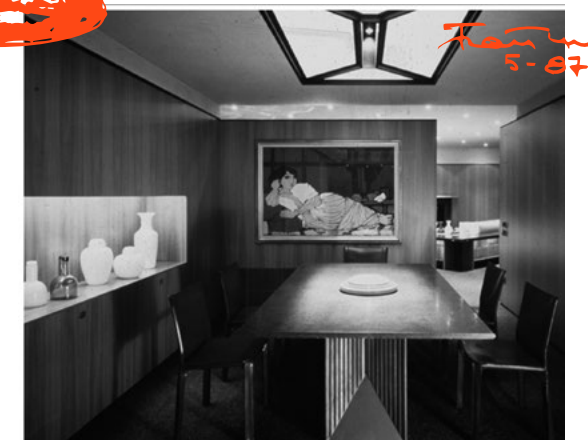
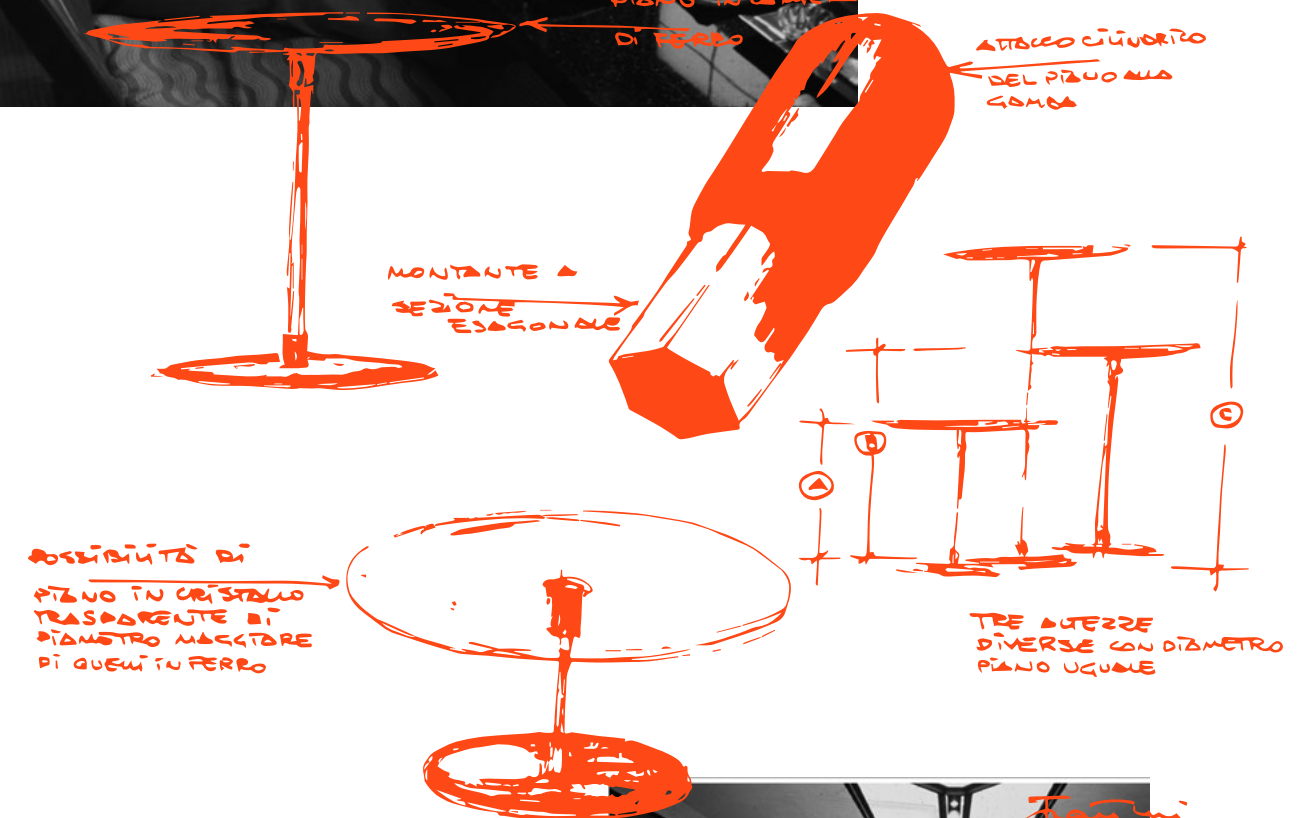

## Lodovico Acerbis



## Gianfranco Frattini

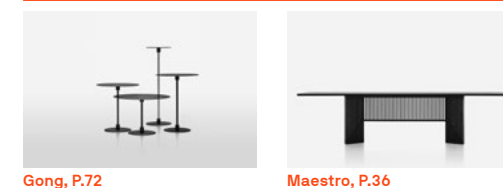



Flat Goito street, Milan, 1953-59.

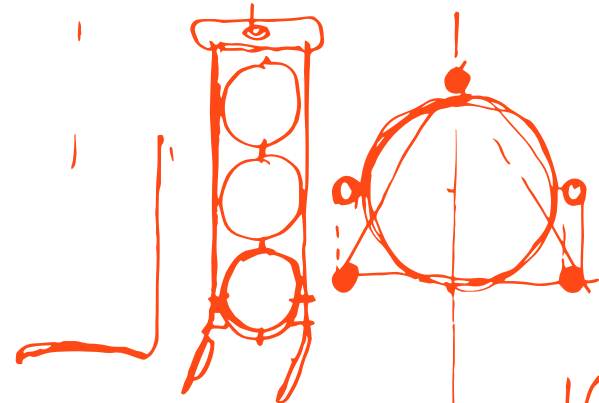
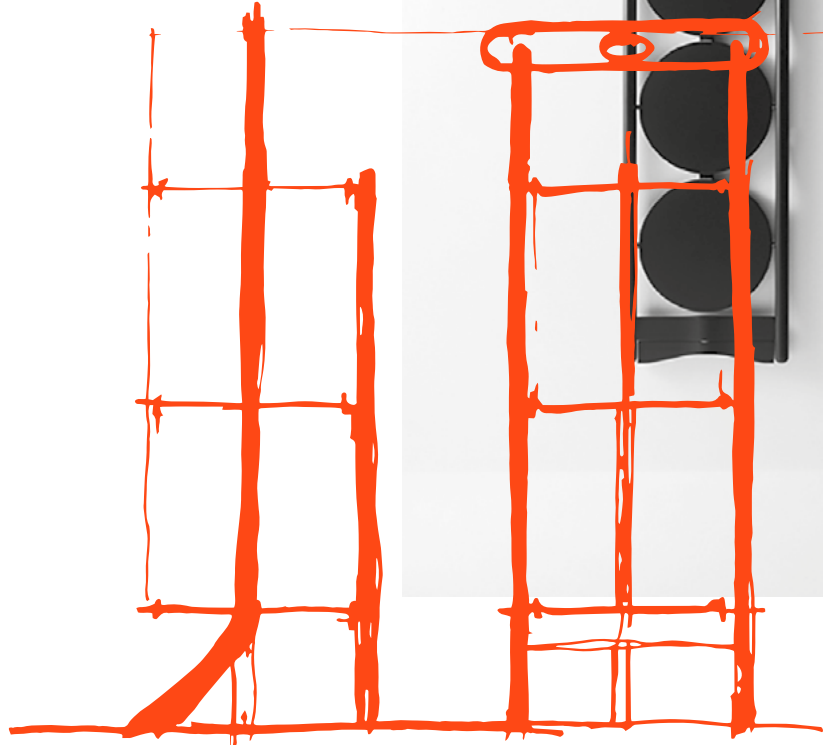

16 cum. &



11/2/56

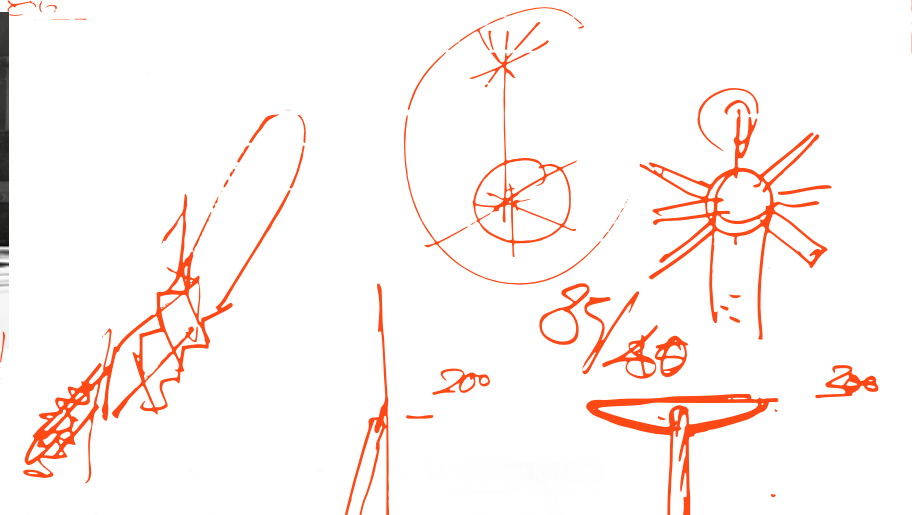

# Vico Magistretti



Florian, P.79



Spiros, P.85

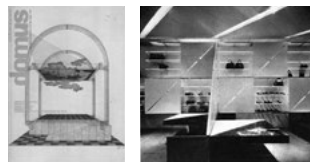

Ferragamo store, New York, 717 Fifth Avenue, Domus 546, 1975.

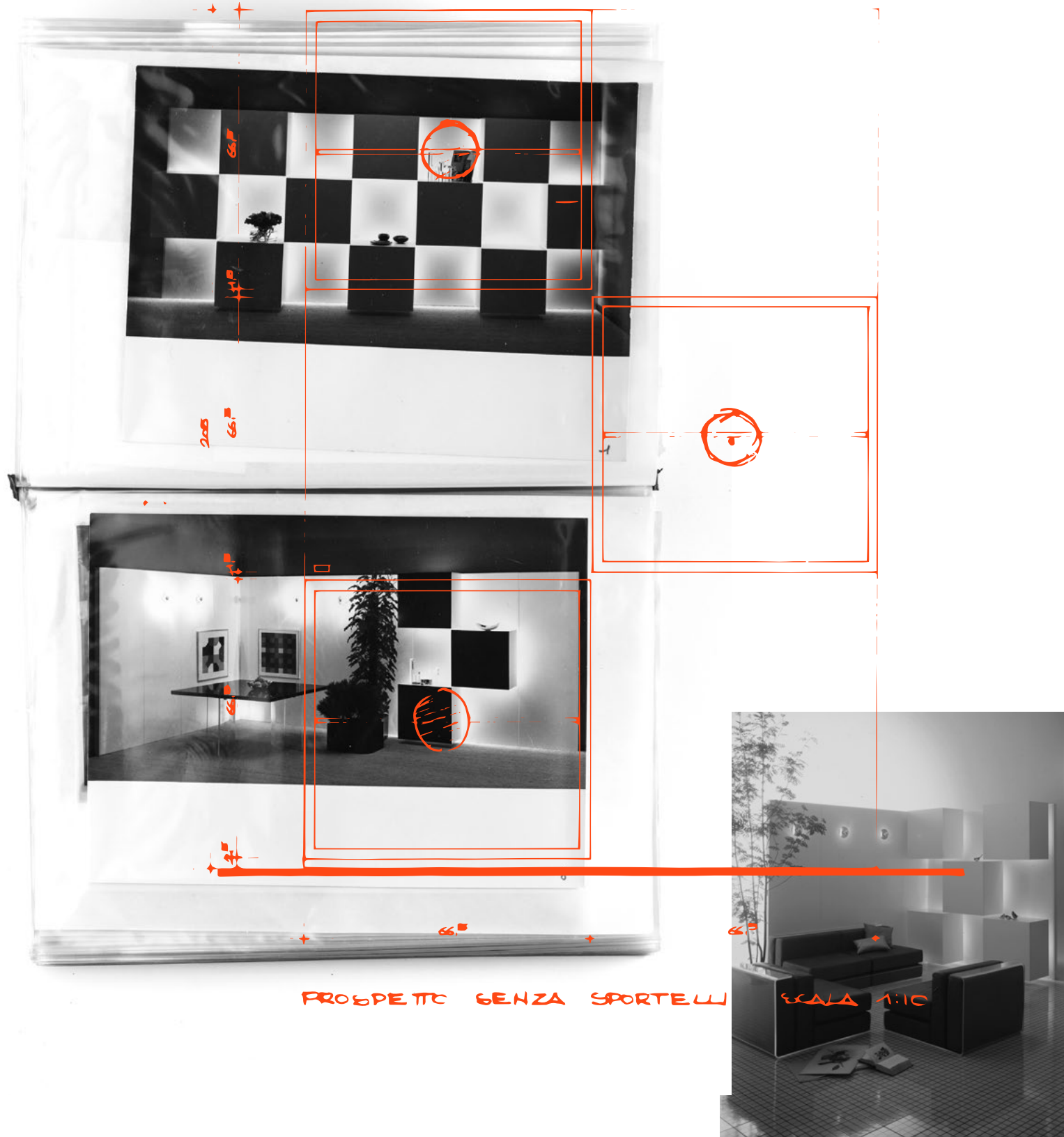

170

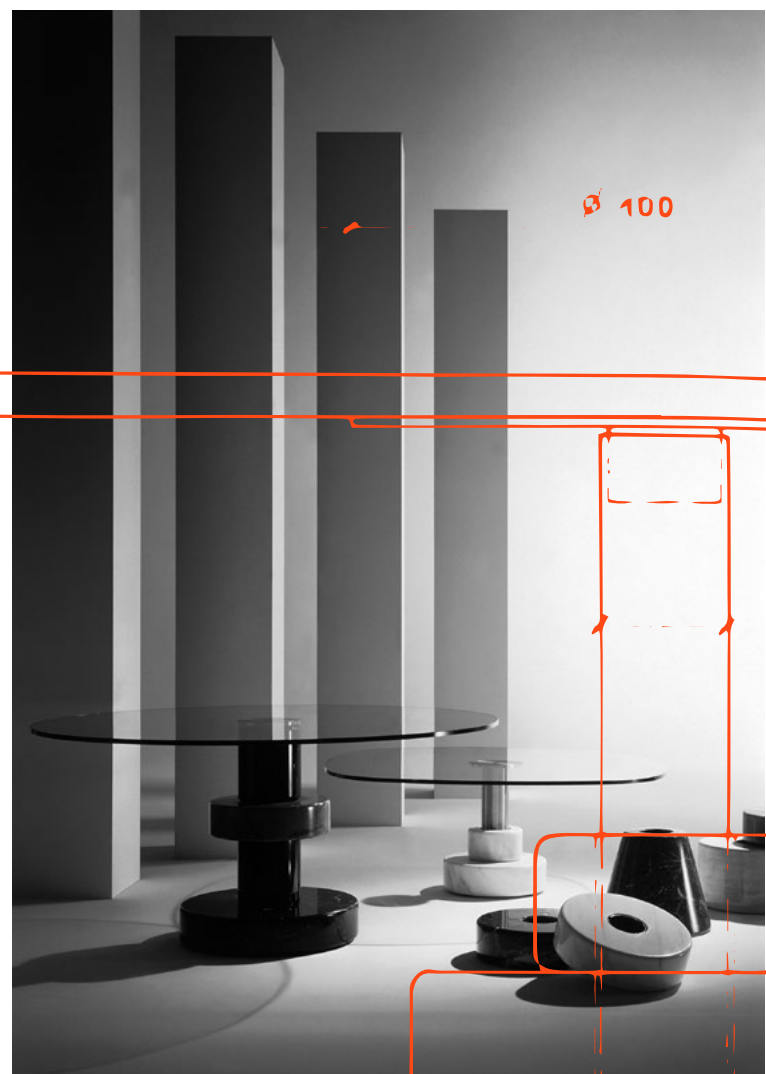

# Roberto Monsani

Prodotti Products



Life sofa, P.67 Life system, P.88

# Giotto Stoppino

Prodotti Products

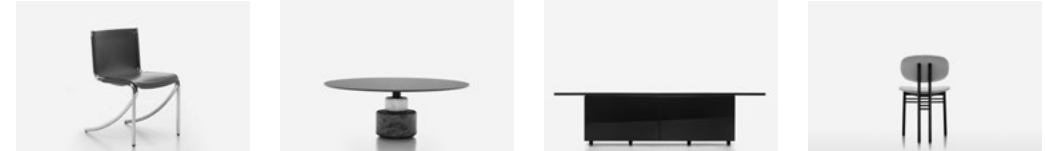

Jot, P.32 Menhir, P.26 Sheraton, P.20 Med, P.42





Beetle under a leaf, 1965, Malo (Vicenza). In collaboration with Gio Ponti.

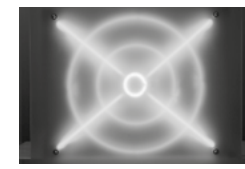

Base+Line, 2003

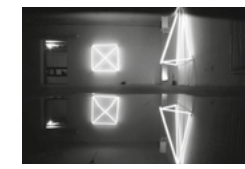

Frammenti di riflessione, 1979, Palazzo dei Diamanti, Ferrara.

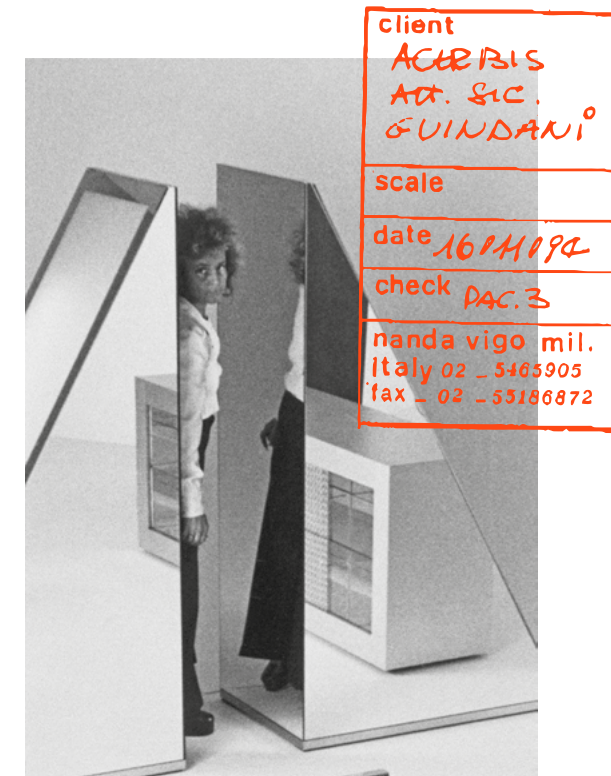
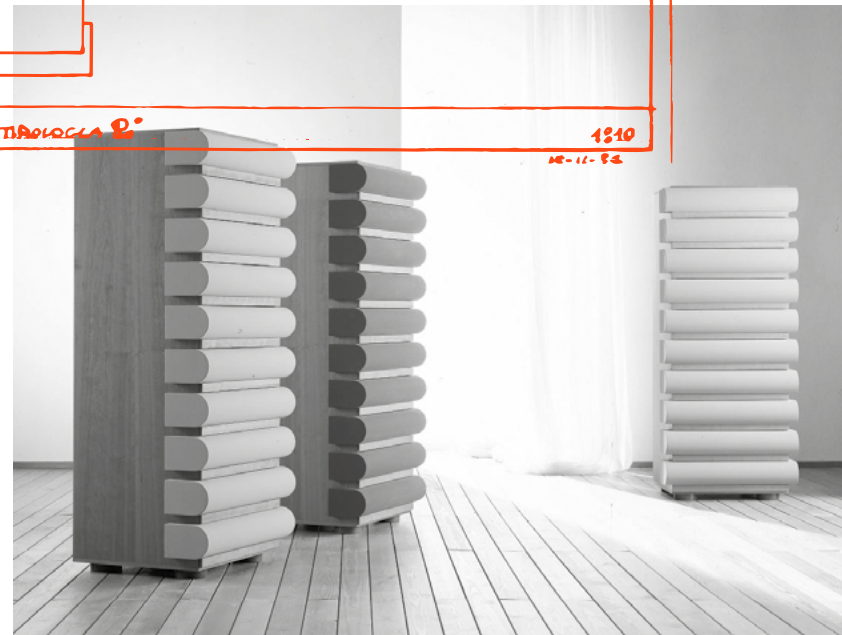
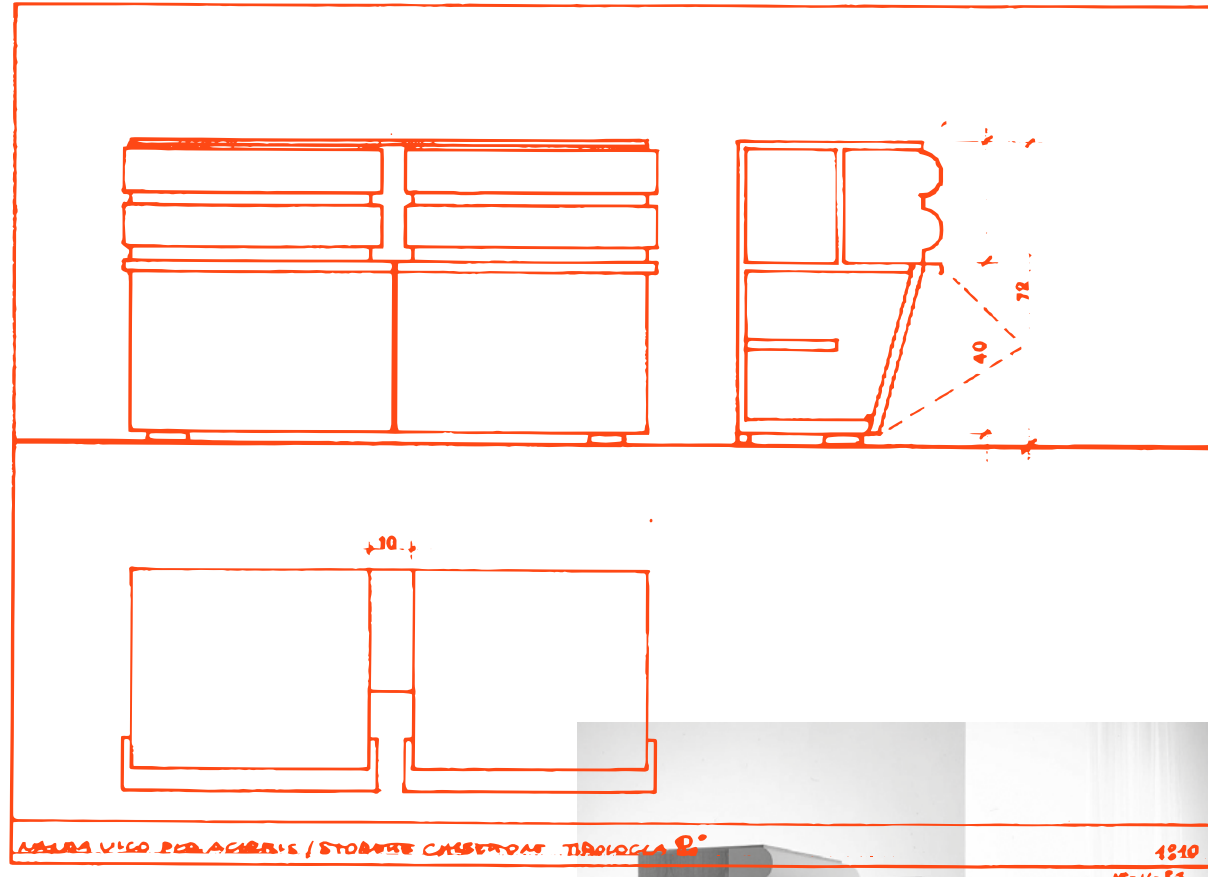

ALBERTI STUDIO PROGETTO  
COMODINO STORET.  
A PREZZO, CORDIALI SALUTI  
Medaigo

nanda vigo - studio architettura - design - operazioni visive



# Nanda Vigo



Storet, P.60



New York Subways, 1966.



United Colors of Benetton, 1996.



Salone del Mobile, 1995.

# Remasters

IT Remasters è la prima collezione curata dai nuovi direttori creativi, che conta tredici prodotti selezionati tra i più audaci capolavori dell'archivio, reinterpretati magistralmente con nuove finiture, materiali inediti, proporzioni e soluzioni tecniche attualizzate, per tornare ad essere protagonisti nelle case di oggi. Una collezione eclettica e autentica composta da oggetti disegnati da mani diverse in epoche differenti, la cui forte personalità viene enfatizzata all'interno del nuovo catalogo. La narrazione estetica presentata esprime la capacità dei prodotti di inserirsi in ambienti molto diversi tra loro, mettendo in evidenza la loro forte identità e trasversalità, senza pretendere di offrire un ambiente coordinato, ma piuttosto di celebrare l'intelligenza e il valore intrinseco di prodotti che possono vivere singolarmente o coesistere entrando in relazione tra loro negli spazi.

EN Remasters is the first collection curated by the new creative directors, featuring thirteen products selected among the most daring and original archival masterpieces, reinterpreted with new finishes, new materials, proportions and updated technical solutions, to become protagonists once again in today's homes. An eclectic and authentic collection made up of objects designed by several hands in different eras, whose strong personality is enhanced in the new catalogue. The aesthetic narrative presented expresses the ability of these products to fit into very different environments, highlighting their strong identity and transversality, without pretending to offer a coordinated environment, but rather celebrating the inherent intelligence and value of products that can live individually or coexist in relation to each other in spaces.

## Collezione

IT Basata su processi produttivi di alta precisione e su un'eredità consolidata di eccellenza artigianale, Acerbis ha rivoluzionato le soluzioni creative per i contesti abitativi contemporanei con il moderno arredamento modulare, grazie alla reinterpretazione da parte dei suoi designer di tavoli, credenze, librerie e mobili contenitori. Alla costante ricerca di usi innovativi dei materiali, Acerbis è diventata un punto di riferimento nell'ambito delle laccature di alta qualità, conferendo livelli mai visti prima di lucentezza e durevolezza. Con un talento unico per sistemi speciali di chiusura, cerniere e altre componenti personalizzate, retaggio della tradizione artigianale nella produzione dei mobili, Acerbis offre ai suoi clienti un'esperienza di lusso che combina estetica concettuale e funzionalità nelle soluzioni d'arredo.

EN Imbued with precision production and a finely-honed heritage in high craftsmanship, Acerbis innovated creative solutions for contemporary living spaces, creating the vanguard in modern modular furnishings, with designers' reimaginings of tables, credenzas, cabinets, and storage pieces. Continually exploring novel material uses, Acerbis established a new touchstone in high quality lacquers, imbuing them with previously unseen levels of gloss and durability. A unique talent for specialized closing mechanisms, hinges, and other custom hardware, descended from the furniture maker's artisan tradition, imparted a fundamental luxury experience of design for users to match the conceptual aesthetic solutions of the furnishings.

## Sinestesia

IT Un video diretto da Lorenzo Gironi, girato interamente su pellicola, nel quale sette prodotti, parte integrante del patrimonio di Acerbis, riemergono sotto una nuova luce. Un gioco, un susseguirsi di contaminazioni inedite, suggestioni, suoni, opposizioni e unioni.

Scopri il video

EN A video directed by Lorenzo Gironi, shot entirely on film, in which seven products, integral part of the Acerbis' heritage, re-emerge under a new light. A game, a succession of unprecedented contaminations, suggestions, sounds, oppositions and unions.

Discover the video



Job	Project	Drawn By	Date
ACERBIS	DRYING TABLE BASE	D. LAU	6/16/67
	EXPLODED VIEW	Number	Scale
		2 OF 2	NONE

Vignelli Associates Designers  
475 Tenth Avenue New York, New York 10018  
212 244 1919

# Lella & Massimo Vignelli



Serenissimo, P.48



Creso, P.54

Prodotti Products

Remasters ●  
Collection

Products



Alterego, P.92



Alterego low, P.96



Axis, P.101



Creso, P.54 ●



Florian, P.79 ●



Ghostwriter, P.105 ●



Gong, P.72



Grand Buffet, P.108 ●



Jot, P.32



Judd, P.113 ●



Life sofa, P.67

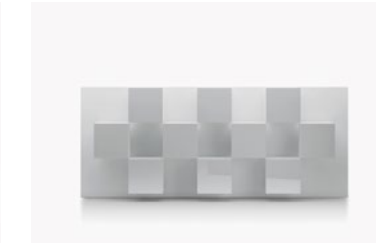

Life system, P.88 ●



Litt, P.115



Ludwig, P.116



Maestro, P.36



Maxwell, P.121 ●



Med, P.42



Menhir, P.26 ●



Moodboard, P.125 ●



Moodboard Console, P.129



NC Sideboard, P.132



Outline, P.135



Pond, P.139



Serenissimo, P.48 ●



Sheraton, P.20



Spiros, P.85 ●



Steel, P.143 ●



Storet, P.60 ●

# Sheraton

Design Giotto Stoppino, Lodovico Acerbis  
 Year 1977  
 1979, Sheraton wins the ADI Compasso d'Oro

Rispecchiando appieno il ruolo di Giotto Stoppino e Lodovico Acerbis come esponenti di spicco del design italiano, Sheraton combina una forma elegante e rivoluzionaria con funzionalità innovative. Vincitore del Compasso d'Oro nel 1979, Sheraton fa parte della collezione permanente del Victoria and Albert Museum di Londra e oggi si arricchisce di nuove laccature in sei toni contemporanei.

Reflecting Giotto Stoppino and Lodovico Acerbis's role as a leading exponent of modern Italian design, the Sheraton sideboard combines a sleekly groundbreaking shape with innovative functionality. The winner of the Compasso d'Oro in 1979, the seminal design forms part of the permanent collection at London's Victoria and Albert Museum, and today sees new editions of the wood cabinet finished with Acerbis's distinctive glossy lacquers in six new contemporary tones.

1 Un'icona del design, fuori dal tempo e dalle mode.  
 2 Contenitore con ante ad apertura "scivolorotante", un sistema inedito che combina l'apertura scorrevole con quella a cerniera.  
 3 Corpo del mobile laccato opaco, nello stesso colore degli esterni. Cassetto in essenza di Noce tinto scuro; 3 ripiani in vetro trasparente.

1 A design icon, a timeless classic.  
 2 A sideboard with "sliding-hinged" open doors. A brand-new system that combines a sliding and hinged opening.  
 3 Case in matt lacquer, in the same colour as the exterior. Drawer in veneer dark stained walnut; 3 transparent glass shelves.





Gong, P.72

● Menhir, P.26 ●

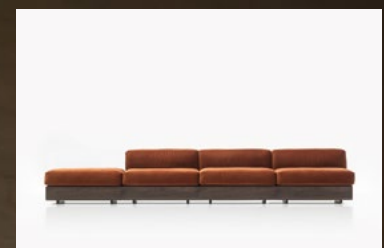

Life sofa, P.67 ●





# Menhir

Design	Giotto Stoppino, Lodovico Acerbis
Year	1983

Grazie a un approccio audace ai materiali, i tavolini Menhir diventano una composizione di colori e trame che illustrano in modo eloquente la semplicità scultorea delle forme ideate da Lodovico Acerbis e Giotto Stoppino.

Connotata da un classicismo di stampo greco, la colonna del tavolo collega la monumentale base in marmo, opaca nella sua versione contemporanea, al piano del tavolo disponibile in noce tinto scuro, frassino nero e in otto laccature, creando uno straordinario connubio di forme e colori.

With a daring approach to materials, the Menhir low table becomes a composition of colors and textures that eloquently illustrates the sculptural simplicity of Lodovico Acerbis and Giotto Stoppino's inventions of new forms.

With a Greek-like classicism, the table's column connects the monumental marble base, matte in its contemporary version, to a tabletop newly rendered in lacquered wood or black ash wood and dark stained walnut, creating a striking exchange between colors and elements.

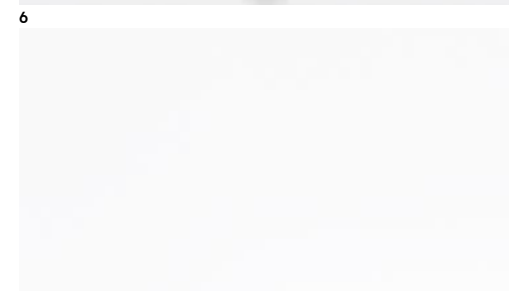
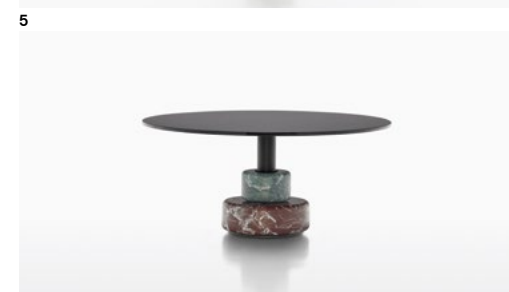
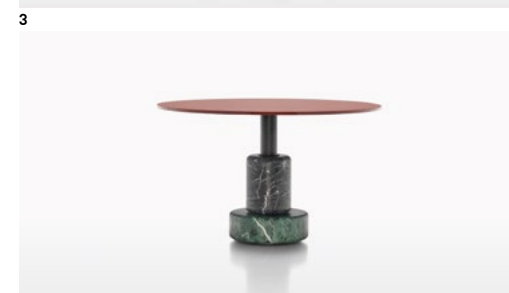

- 1 Top ø120: Noce tinto scuro ES59.
- 2 B+E versione; ø100 H36,2 cm.
- 3 C+D versione; ø80 H48,8 cm.
- 4 A versione; ø120 H42,5 cm.
- 5 C+E versione; ø80 H36,2 cm.
- 6 Consolle A+E versione; L120 D40 H80,2 cm.

- 1 Top ø120: dark stained walnut ES59.
- 2 B+E versione; ø100 H36.2 cm.
- 3 C+D versione; ø80 H48.8 cm.
- 4 A versione; ø120 H42.5 cm.
- 5 C+E versione; ø80 H36.2 cm.
- 6 Consolle A+E versione; L120 D40 H80.2 cm.



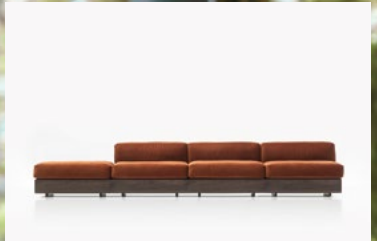

Life sofa, P.67





Life sofa, P.67

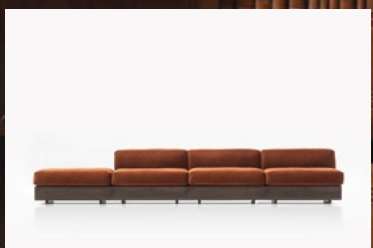

# Jot

Design Giotto Stoppino

Year 1976

Esaltando l'acciaio come nella tradizione Bauhaus, la sedia Jot con struttura in tubolare cromata proietta la sua forma sinuosa nell'era contemporanea con una nuova versione, pura nella sua essenza e bellezza, grazie al metallo lucido e al cuoio naturale.

La sedia Jot rappresenta un esempio iconico dell'uso sapiente di Giotto Stoppino dello stile a sbalzo e della ricerca sui materiali.

Celebrating stainless steel in the Bauhaus tradition, the tubular chrome-framed Jot chair takes its swooping, balletic form into the contemporary era with a new version purified of any paint or dye that would hide the essence of its powerful metal and rawhide leather elements. An iconic example of Giotto Stoppino's masterful use of cantilevered chair styles and his exploratory method with materials.

1



32

Jot

Sedie e divani

Chairs and sofas

2



3



33

Acerbis

1 Una sintesi perfetta tra forma e funzione.

2-3 Sedia con telaio in metallo disponibile nelle finiture verniciato opaco nichel nero o cromo.

4-5 Rivestimento in cuoio doppio nei colori nero, grigio scuro, grigio foca, tortora, testa di moro, marrone, naturale.

1 A perfect synthesis between form and function.

2-3 Chair with metal frame available in matt black nickel or chrome painted finishes.

4-5 Double saddle-hide upholstery in black, dark grey, foca, turtledove, testa di moro, brown, natural.

Remasters

4



5





Maestro, P.36



# Maestro

Design	Gianfranco Frattini
Year	1997

Con la precisione e la vivida identità che da sempre hanno contraddistinto i lavori di Gianfranco Frattini, il tavolo Maestro è stato progettato per portare funzionalità e perfezione negli spazi abitativi.

Oggi, nelle versioni da 2,5, 3 e 3,5 metri di lunghezza, diventa più imponente nelle sue dimensioni e più scenico nel suo impatto materico grazie al legno noce tinto scuro e al frassino nero. Il gioco dei ritagli che caratterizza il basamento e il ponte centrale richiama l'architettura tradizionale giapponese.

With the precision and vivid identity that Gianfranco Frattini imbued in his work, the Maestro table was designed to conjure function and perfection in living spaces. Today, at versions in 2,5, 3 and 3.5 meters in length, it becomes grander in its scale for modern entertaining needs, and more dramatic in its material impact, with black ash wood and dark stained walnut making dark silhouettes of the long, cantilevered wings of the table and its linear play of cutouts that recalls traditional Japanese architecture.

- 1 L'attuale riedizione rispetta fedelmente il design originale, con il particolare basamento composto da sottili listelli in legno massello.
- 2 Il tavolo è sempre monomaterico, H73 cm, nelle dimensioni: P90 x L250; P100 x L300; P100 x L350; P120 x L350 cm.
- 3-4 Piano con particolare impiallacciatura intarsiata nelle finiture Frassino nero ES60 e Noce tinto scuro ES59.

- 1 The current re-edition version is faithful to the original design, with its distinctive base made up of thin slats of solid wood.
- 2 The table is made from a single material, H73 cm in the following sizes: D90 x L250; D100 x L300; D100 x L350; D120 x L350.
- 3-4 Top with special inlaid veneer, in black ash ES60 and dark stained walnut finishes ES59 and dark stained walnut ES59.



36

Maestro

Tavoli

Tables

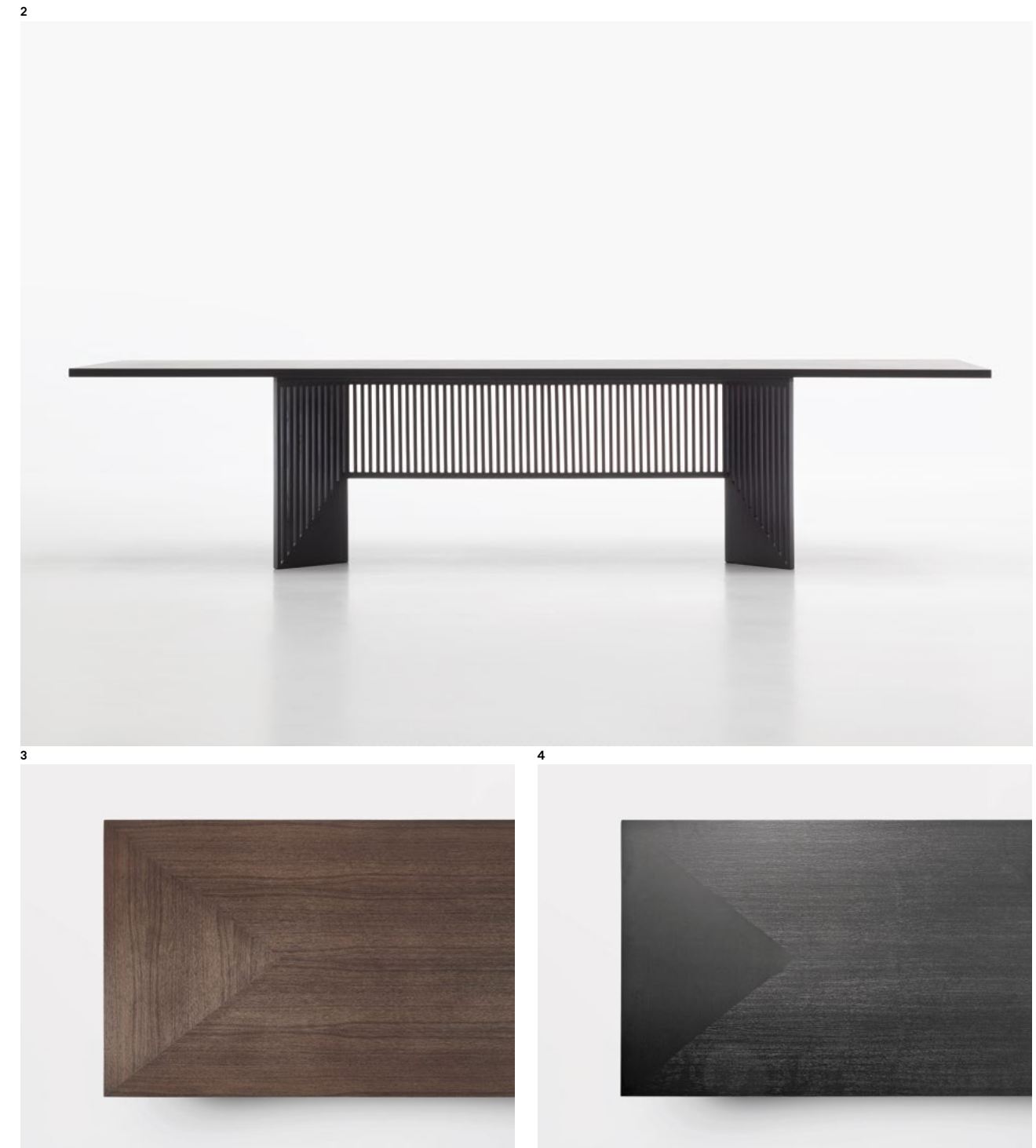

37

Acerbis

Remasters

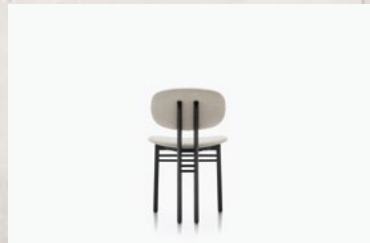

Med, P.42





Jot, P.32



● Menhir Consolle, P.26 ●



# Med

Design	Giotto Stoppino, Lodovico Acerbis
Year	1983

La sedia Med racchiude l'approccio sperimentale di Giotto Stoppino e Lodovico Acerbis verso la materia. Progetto del 1983 viene riprodotto nel rispetto del disegno autentico riscoperto negli archivi storici di Acerbis. Med rappresenta una sapiente combinazione di forme e materiali che esaltano le caratteristiche del legno e la sua lavorazione artigianale. Si distingue per la forte riconoscibilità del profilo della gamba che richiama l'iconico Flatiron Building in Madison Avenue, New York, tratto distintivo anche del montante della libreria Madison, realizzata dagli stessi designers sempre per Acerbis.

The Med chair embodies Giotto Stoppino's experimental approach to materials. Project from 1983 reproduced respecting the authentic design re-discovered in Acerbis' historical archives. Med represents a skilful combination of shapes and materials that enhance the characteristics of curved wood and its craftsmanship. It stands out for the strong recognisability of the leg profile that recalls the Flatiron Building on Madison Avenue, New York, which is also a distinctive feature of the upright of the Madison bookcase, created by the same designers for Acerbis.

1 Struttura: Noce tinto scuro ES59;  
Tessuto: Opera 39.  
2/3 Struttura: Frassino nero ES58;  
Tessuto: Paradise 060.

1 Structure: dark stained walnut ES59;  
Fabric: Opera 39.  
2/3 Structure: Black ash ES58;  
Fabric: Paradise 060.

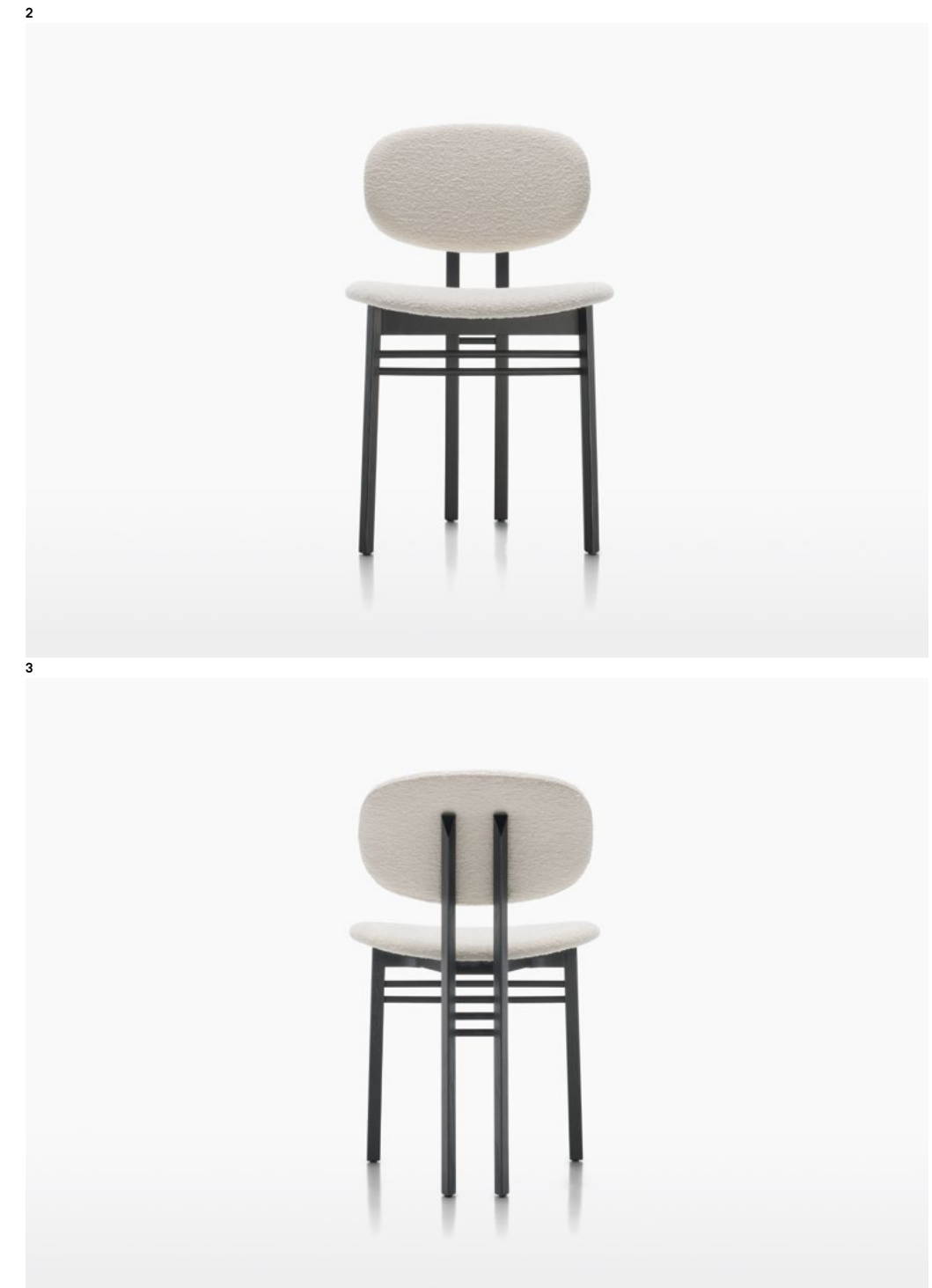







Serenissimo, P.48



# Serenissimo

Design Lella & Massimo Vignelli, David Law

Year 1985

1987, Serenissimo wins the ID Annual Review award in the United States

Con la precisione delle sue linee, Serenissimo traduce il concetto di tavolo in una composizione grafica con quattro colonne e una barra orizzontale in acciaio per far fluttuare il piano d'appoggio. In linea con il design originale di Lella e Massimo Vignelli, è una creazione che si esprime attraverso la sua geometria e i suoi materiali. Le forme elementari caratterizzate da ricercate finiture metalliche e da morbide tonalità dello stucco veneziano, insieme ad un ampio piano in vetro — che raggiunge fino a tre metri di lunghezza — disteso sopra una base ad altare, danno vita ad una composizione armonica dalle dimensioni monumentali.

The precisely delineated Serenissimo renders a table as a graphic composition, with four columns and a linear steel girder to float the table top above. In the key of Lella and Massimo Vignelli's original design, the creation speaks through its geometry and materials, with its elemental shapes defined by refined metallic finishes or soft tones of Venetian stucco, and by a vast glass top — up to three meters long — extended atop the altar-like base, for a harmony composed of monumental proportions.

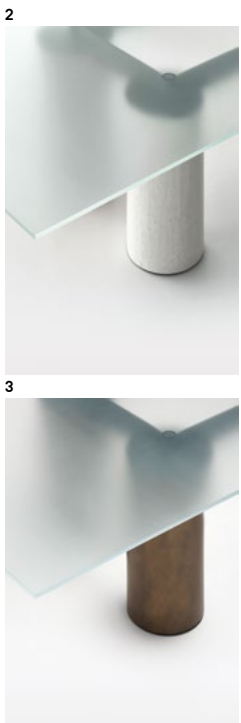

- 1 Base: encausto verde EN02; Top: cristallo opalescente extrachiaro VT05.
- 2 Base: encausto bianco EN01; Top: cristallo opalescente extrachiaro VT05.
- 3 Base: verniciato opaco bronzo orbitale MT14; Top: cristallo opalescente extrachiaro VT05.
- 4 Base: encausto terracotta EN03; Top: cristallo nero colato VT18.
- 5 Base: encausto verde EN02; Top: cristallo opalescente extrachiaro VT05.

- 1 Base: green encaustic EN02; Top: extraclear opalescent glass VT05.
- 2 Base: white encaustic EN01; Top: extraclear opalescent glass VT05.
- 3 Base: matt painted orbital bronze MT14; Top: extraclear opalescent glass VT05.
- 4 Base: terracotta encaustic EN03; Top: black cast glass VT18.
- 5 Base: green encaustic EN02; Top: extraclear opalescent glass VT05.





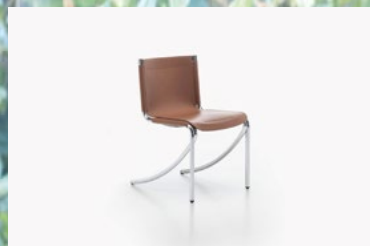

Jot, P.32



Storet, P.60



# Creso

Design Lella & Massimo Vignelli

Year 1988

1989, Honourable Mention at the ADI Compasso d'Oro

Con la sua forma singolare dalla silhouette monolitica, Creso fa ricorso al supporto di un solo piedistallo per trasformare un tavolo nel tipo di geometria vigorosa che era alla base della visione di Lella e Massimo Vignelli.

Valorizzato da un'interpretazione più fedele delle idee di Vignelli, il nuovo Creso sperimenta un uso dei materiali capace di evidenziare la potenza del suo design, grazie a un piano rotondo e a una base a colonna, realizzati in travertino, o a una superficie in vetro o marmo, sostenuta da una base in varie finiture metalliche.

A singular form with a monolith's silhouette, the Creso experiments with a sole pedestal of support to transform a table into the kind of vigorous geometry that defined the eye of Lella and Massimo Vignelli.

Returned to a more faithful rendering of Vignelli's ideas, the new Creso explores a use of materials that underlines the potency of the design, with its round top and pillar base crafted formidably in travertine, or topped by glass or marble, braced by a with various metallic finishes.

1 Base e top: marmo Travertino opaco MR08.  
2 Top Ø160: marmo arabescato bianco opaco MR02;  
Base: acciaio lucido ottonato MT03.  
3 Top Ø160: marmo nero Marquinia MR05;  
Base: verniciato opaco canna di fucile MT13.

1 Base and top: matt Travertine marble MR08.  
2 Top Ø160: white arabesque marble matt MR02;  
Base: Satin polished steel - brass effect MT03.  
3 Top Ø160: Marquinia black marble MR05;  
Base: matt painted gunmetal MT13.





Jot, P.32





Med, P.42



# Storet

Design Nanda Vigo

Year 1994

2020, Best of the Year Awards, Interior Design Magazine, USA  
 2022, 2nd place, Best 10 products of 2022 Est Living Magazines Awards, Australia

Una cassetiera giocosa e vivace, Storet incarna il tocco magico e visionario delle creazioni di Nanda Vigo, oggi resa più contemporanea da nuove finiture e proporzioni. Sia nella versione alta, che nella variante comodino progettata da Vigo ma prodotto per la prima volta solo ora, Storet riflette i progressi odierni della produzione: l'artigianale lavorazione del legno enfatizza la decennale competenza di Acerbis nella tradizione ebanista. Il mobile, pur essendo realizzato in un unico materiale, crea un sinuoso gioco di chiaro scuri, che esaltano la naturale bellezza del legno e la vivacità delle laccature.

A playful, spirited pillar of drawers, the Storet cabinet epitomizes the visionary touch of Nanda Vigo's designs, now modernized with a brightly lacquered wood contrast and brand new proportions. In both its elongated vertical edition, and in the nightstand designed by Vigo but manufactured for the first time only now, the Storet reflects today's advances in production, with the walnut's visible grain illuminating Acerbis's modern expertise in utilizing extensive wood surfaces. The cabinet, though made entirely of a single material, creates a potent game of colorplay, tempered by the pacifying shades and the natural quality of the wood.



60 Storet

Sistemi parete e librerie

Wall units and shelving

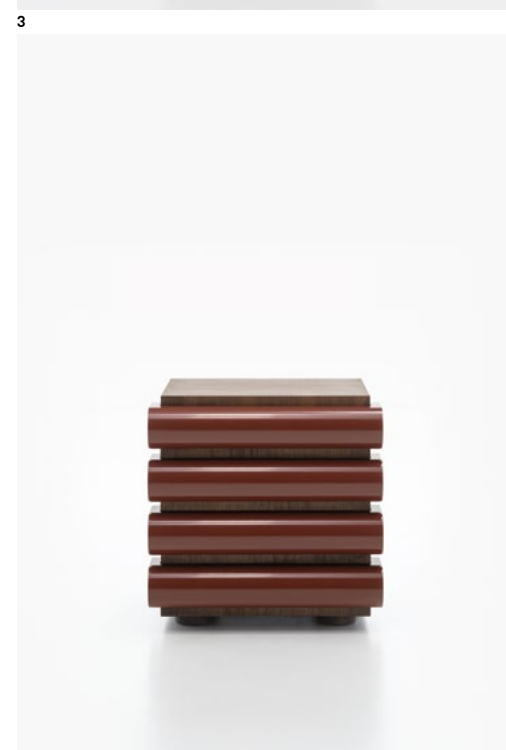

61 Acerbis

- 1 Struttura: Noce scuro ES59; Cassetti: laccato lucido verde scuro LL22.
- 2 Settimanale. Struttura: Frassino nero ES60; Cassetti: laccato lucido verde scuro LL22.
- 3 Cassetiera. Struttura: Noce tinto scuro ES59; Cassetti: laccato lucido rosso mattone LL24.
- 4 Cassetiera. Struttura: Noce tinto scuro ES59; Cassetti: laccato lucido rosa LL21.

- 1 Structure: dark walnut ES59; Drawers: glossy lacquered dark green LL22.
- 2 High chest of drawers. Structure: Black ash ES60; Drawers: glossy lacquered dark green LL22.
- 3 Low chest of drawers. Structure: dark stained walnut ES59; Drawers: glossy lacquered brick red LL24.
- 4 Low chest of drawers. Structure: dark stained walnut ES59; Drawers: glossy lacquered pink LL21.

Remasters







1 Il design compatto consente una grande versatilità.  
2 Disponibili gli elementi: modulo seduta, pouf S e pouf M.  
3 Il tessuto del rivestimento è confezionato in modo da esaltarne la morbidezza, ricopre il divano in ogni sua parte ed è completamente removibile.

1 The compact design allows great versatility.  
2 The following elements are available: seat module, pouf S and pouf M.  
3 The upholstery fabric enhances its softness, covers the sofa in all its parts and is completely removable. Possibility of purchasing additional cover upholstery.

# Life sofa

Design Roberto Monsani

Year 1975

Nell'immaginare nuovi stili di vita, Roberto Monsani ha sviluppato soluzioni per ripensare la casa, e il divano Life — così all'avanguardia da non essere mai stato prodotto in serie ai tempi di Monsani — conserva il suo originale aspetto moderno. Mantenendo il suo design modulare e flessibile, oggi l'originale struttura del divano in plexiglas è stata allungata e aggiornata con versioni in noce tinto scuro e frassino nero, ideali per gli spazi abitativi contemporanei. I cuscini in piuma, estremamente comodi e pensati per un relax informale, sono resi ancor più accoglienti dal rivestimento in velluto.

In envisioning new styles of living, Roberto Monsani imagined solutions to reshape the home, and the Life couch — so avant-garde it was never produced in series in Monsani's day — retains its modern edge. Maintaining its modular and flexible design, today the sofa's original lucite frame has been elongated and updated with versions in dark stained walnut and black ash for contemporary living ideals. Designed to invite casual lounging, the supremely comfortable down cushions are now rendered ever more inviting in velvet, with softened shapes for absolute ease.

2



3



66

Life sofa

Sedie e divani

Chairs and sofas

1



67

Acerbis

Remasters



Gong, P.72



Menhir, P.26

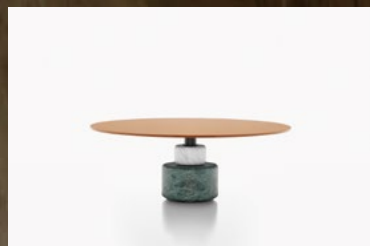

Menhir, P.26



Storet, P.60



# Gong

Design Gianfranco Frattini

Year 1987

1989, Selected for the XV Compasso d'Oro Award

Rappresentativa del design rigoroso di Gianfranco Frattini, la famiglia di tavolini Gong riemerge con tutta la sua grazia ed estro formale in diverse altezze e diametri: le nuove proporzioni e grandezze sono ideali per ospitare sculture, piante e altri oggetti. I metalli verniciati nelle finiture ottone spazzolato o canna di fucile aggiungono nuova enfasi alla materia, mentre lo stelo in tinta o a contrasto in ottone, il piano e la base in metallo esprimono purezza delle forme.

Emblematic of the rigorous designs of Gianfranco Frattini, the Gong side table reemerges with his quintessential grace and flair of form, now in diverse heights and diameters — a family of proportions for sculptures, plants, and other decor. In a muted brushed finish of brass or gunmetal, the metals present a new emphasis on materiality, with a column in the same colour or contrasting in brass, and a tabletop and base in iron, all in gleaming, elemental purity.



72 Gong Tavolini Low tables



73 Acerbis

- 1 Famiglia di tavolini rotondi interamente in metallo.
- 2 Ø55 H35 cm.
- 3 Ø43 H55 cm.
- 4 Ø27 H80 cm.

- 1 Gong is a range of round metal tables.
- 2 Ø55 H35 cm.
- 3 Ø43 H55 cm.
- 4 Ø27 H80 cm.



Remasters





Gong, P.72





1 Frassino tinto nero ES60.  
2 Tavolino a due piani pieghevole e particolare sistema di chiusura che, con il semplice movimento del piede centrale, consente un rapido stoccaggio occupando poco spazio, o di essere appeso come un'opera d'arte.

1 Black stained ash ES60.  
2 Two-tier folding table and a particular folding system which allows a quick storage while taking up little space or to hang it like an artwork with a simple movement of the central foot.

# Florian

Design Vico Magistretti

Year 1989

Originariamente disegnato da Vico Magistretti nel 1989, Florian è uno dei nuovi progetti 2021 riscoperti negli archivi Acerbis. Ingegnosamente funzionale, Florian rappresenta la straordinaria semplicità di Magistretti: un tavolino leggero a più livelli costruito su una struttura pieghevole ispirata a un manico di scopa, che si ripiega completamente per essere appeso alla parete trasformandosi in un oggetto grafico composto da cerchi e linee. Nella nuova versione, le dimensioni di Florian si adattano alla vita moderna, la sua struttura in legno di frassino si piega dolcemente e rapidamente con un innovativo meccanismo in ottone e il suo impatto grafico è rafforzato dai toni laccati color senape, verde abete e rosso mattone — un democratico passe-partout per la casa contemporanea.

Originally created by Vico Magistretti in 1989, Florian is one of the new 2021 designs remastered from the Acerbis archives. Ingeniously functional, the Florian represents Magistretti's supreme simplicity, with a lightweight, multi-level side table built on a foldable structure inspired by a broom handle, which collapses flat to hang on the wall as a graphic object of circles and lines. In this new version, the Florian's size adapts to modern living, its ash wood frame folds smoothly and quickly with a modern brass mechanism, and its graphic impact is bolstered with lacquered tones of mustard, green spruce and brick — a democratic passe-partout for the contemporary home.

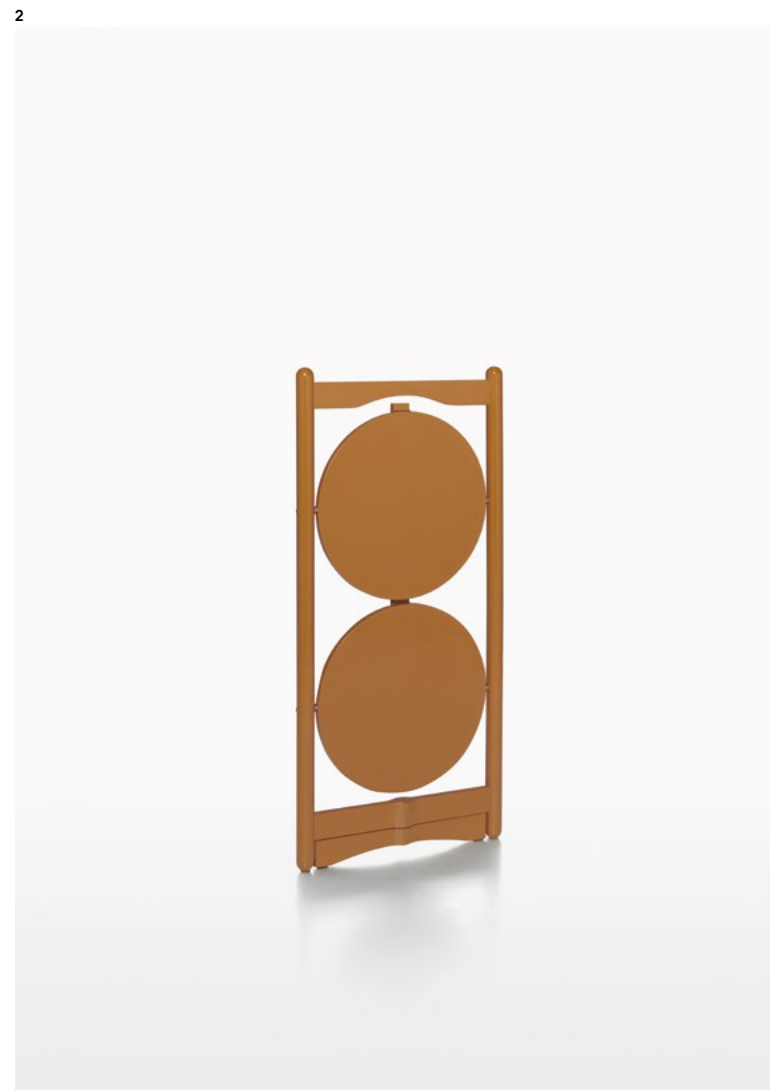

78 Florian



Tavolini Low tables



79 Acerbis Remasters

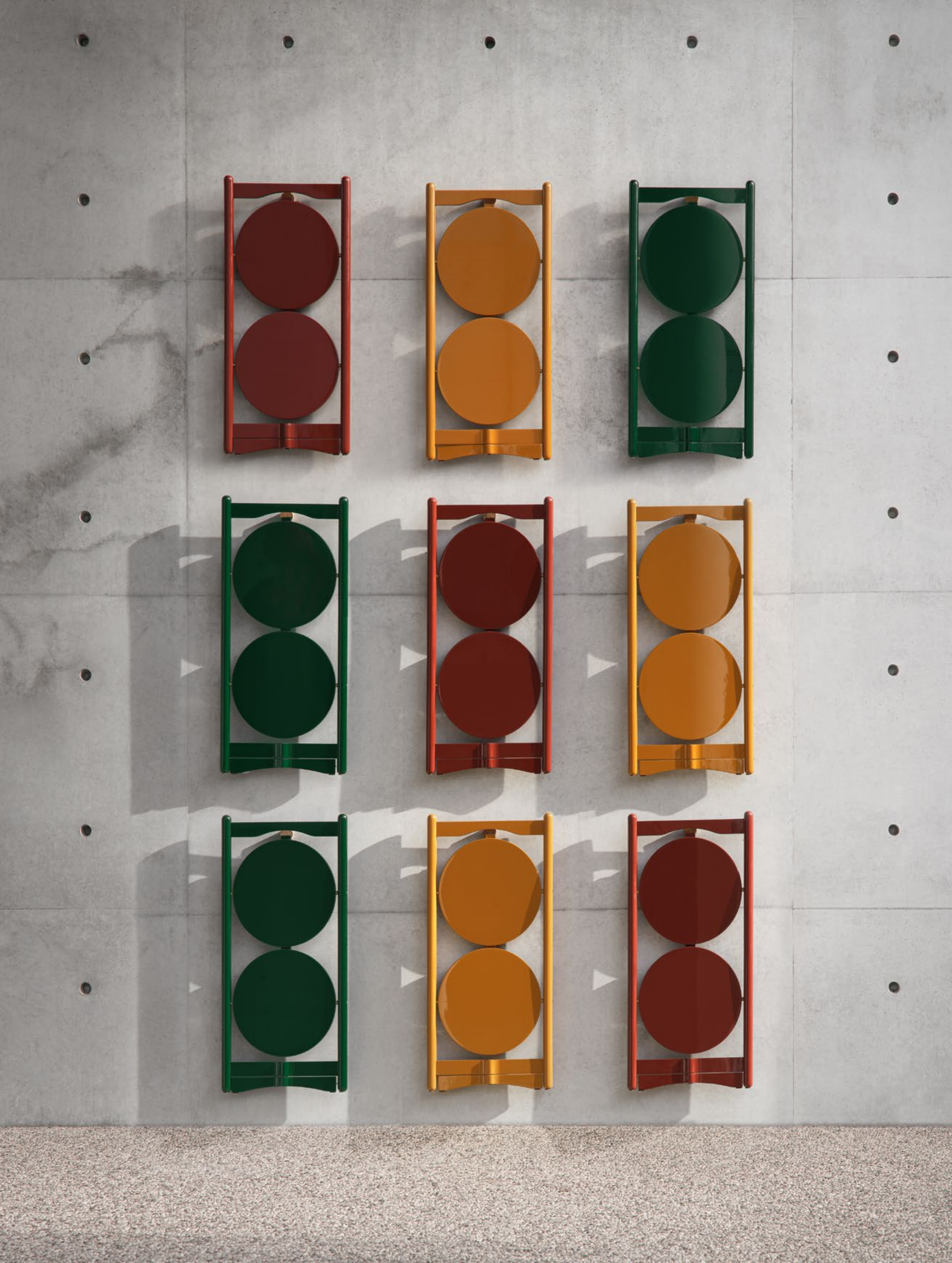



Florian, P.79



1 Base in metallo verniciato grigio micaceo.  
2 Vico Magistretti scrive un pezzo di storia con Spiros, l'appendiabiti realizzato per la collezione Morphos, imitata icona del design internazionale che conquista nel 1988 una Honorable Mention di ID Annual Design Review a New York e viene inclusa nella Permanent Design Collection di Southwest Museum of Science and Technology a Dallas.

1 Base in metal painted micaceous grey.  
2 Vico Magistretti wrote a piece of history with Spiros, the coat rack made for the Morphos collection, a much imitated icon of international design that, in 1988, won an Honorable Mention for the ID Annual Design Review in New York and was included in the Permanent Design Collection at the Southwest Museum of Science and Technology in Dallas.

# Spiros

Design Vico Magistretti

Year 1987

1987, Forum Design 87 Award, Cosmit  
1988, Honourable Mention for the ID Annual Design Review in New York

“La semplicità è la cosa più complicata del mondo” ha detto Vico Magistretti, e il suo virtuosismo con il design purificato è evidente in questa sua prima creazione per Acerbis, usando un cambio di prospettiva per trasformare un oggetto quotidiano — il manico di scopa — in un oggetto di accattivante essenzialità.

"Simplicity is the most complex achievement in the world", said Vico Magistretti, and his virtuosity with purified design is evident in this first creation of his for Acerbis, using a change in perspective to transform an everyday object — the broomstick — into an object of captivating essentialism.



Complementi

Complements



85 Acerbis

Remasters



# Life system

Design	Roberto Monsani
Year	1975

Il sistema Life di Monsani, impercettibilmente riproporzionato e rivisitato all'insegna della versatilità, assume una nuova lussuosità con un vetro satinato rigato da sottili nervature lineari, luci LED diffuse, leggerissime mensole in vetro, e un effetto a scacchiera nei colori vivaci e brillanti delle auto vintage della visione di Meda e Lopez Quincoces. L'illuminazione moderna permette di allineare i cubi a filo con la parete e, in linea con il talento unico per i sistemi di chiusura di Acerbis, le cerniere sono state rese invisibili, a valorizzare le linee marcate del design cubico. Il sistema a parete soddisfa un'esigenza contemporanea in casa con flessibilità, impatto visivo e, naturalmente, la straordinaria qualità e funzionalità di Acerbis.

Monsani's Life system, subtly reproporzioned and redesigned for versatility, takes on fresh luxury with ribbed glass, diffused LED lights, lightweight glass shelves, and its checkerboard effect in the vibrant vintage car colors of Meda and Lopez Quincoces's vision for Acerbis's fine-finish lacquers. Its modernized lighting allows the cubes to sit flush against the wall, and in keeping with Acerbis's specialized closures, its hinges have been rendered invisible, underlining the strong lines of its design. The wall system fulfills a contemporary need in the home with flexibility, visual potency, and Acerbis's exceptional quality and functionality.

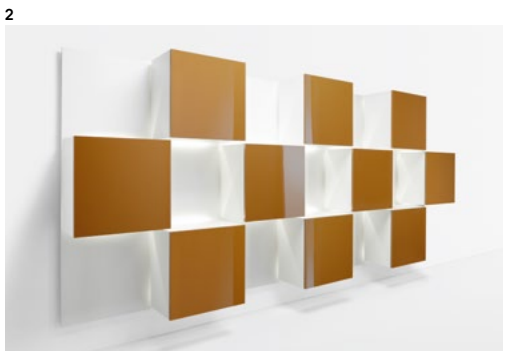

1/2 Struttura: laccato bianco opaco LO73; Ante: laccato lucido giallo senape LL23.  
 3 Ogni cubo è staccato dai pannelli mediante distanziatori in metacrilato bianco opaco. Nell'intercapedine è inserito il corpo illuminante che, oltre a diffondere la luce nella parte posteriore, illumina l'interno del mobile, tramite l'oblò interno.

1/2 Structure: matt lacquered white LO73; Doors of the cubes: glossy lacquered mustard yellow LL23.  
 3 Each cube is separated from the panels by opaque white methacrylate spacers. In the crawl space is inserted the lighting body which diffuses light to the rear and illuminates the inside of the cabinet, through the internal porthole.



88 Life System Sistemi parete e librerie Wall units and shelving

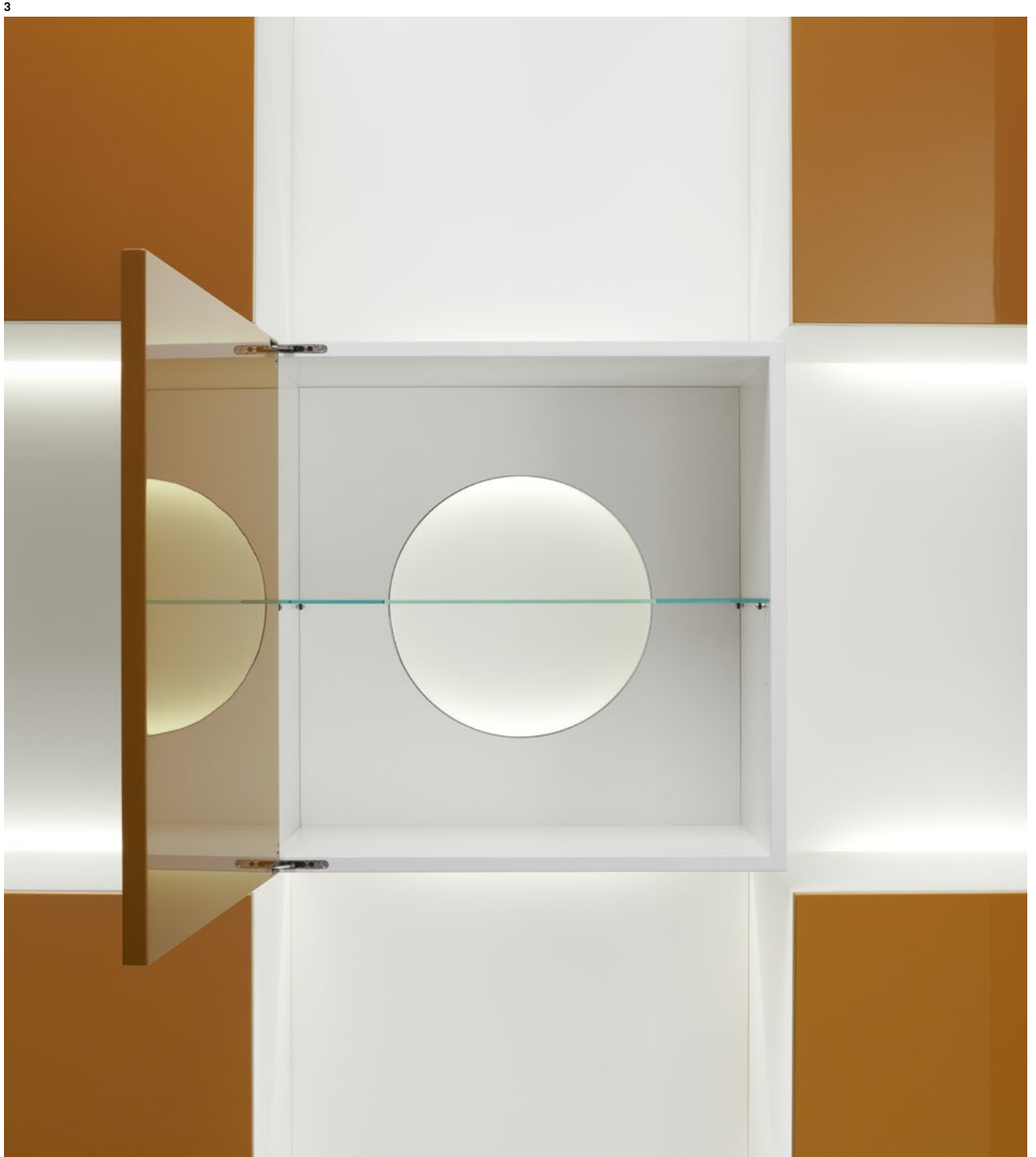

89 Acerbis Remasters



# Alterego

Design	Giacomo Moor
Year	2016

Nelle sue ultime creazioni per Acerbis, Giacomo Moor trasmette alle due credenze verticali Alterego l'effetto della sospensione in un capolavoro di ingegno creativo. L'anta scorrevole a tutta altezza sembra incredibilmente sostenere il peso della struttura, che invece è sorretto dalla base in metacrilato trasparente. Il contrasto tra il legno e le finiture dell'anta ne sottolinea la personalità artigianale. Due credenze con struttura e dimensioni uguali che si distinguono per la posizione asimmetrica dell'anta: uniche utilizzate singolarmente, armoniche se in coppia.

In his latest works for Acerbis, Giacomo Moor imbues the two Alterego vertical sideboards with the mirage of suspension in a marvel of design ingenuity. The full-height sliding door seems, impossibly, to support the weight, which is instead supported by the transparent methacrylate base. The contrast of wood and hand-brushed metal underlines the hand-crafted identity of the sideboards. The two pieces share the same measurements and structure, but the asymmetrical positioning of the sliding door makes each one unique and ideal for pairing.

1	Contenitore e ante battenti: Noce tinto scuro ES59.
2	Anta scorrevole: laccato lucido bordeaux LL20.
3	La base in metacrilato trasparente crea un effetto di sospensione e fa apparire l'anta scorrevole a tutta altezza come unico elemento di sostegno, a prima vista fisso.

1	Cabinet and hinged doors: dark stained walnut ES59.
2	Sliding door: glossy lacquered burgundy LL20.
3	The transparent methacrylate base creates a suspension effect and makes the sliding door seem to be the only support element, which at first appears to be fixed.



92 Alterego Credenze Sideboards



93 Acerbis Collection





Alterego, P.92

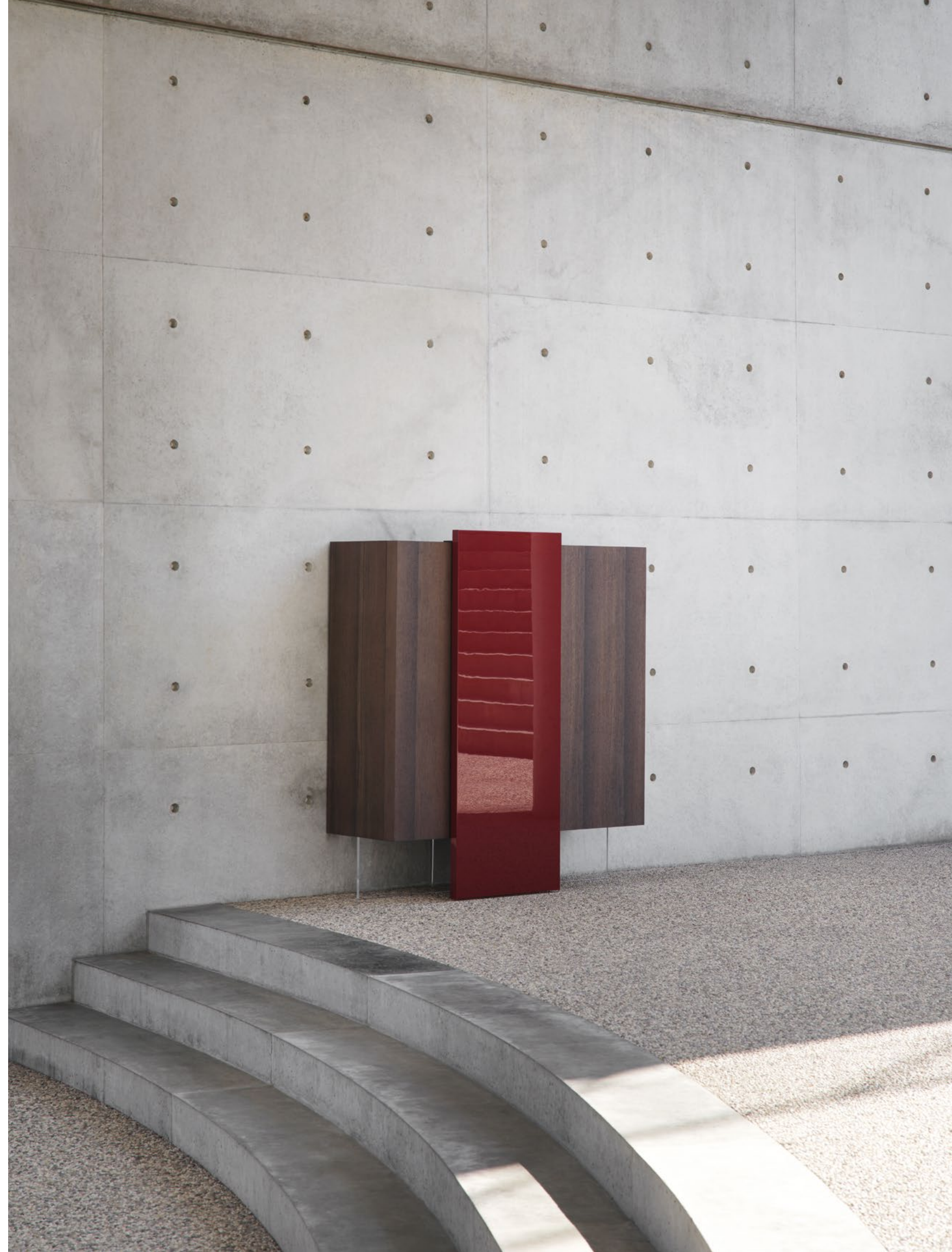

# Alterego low

Design	Giacomo Moor
Year	2018

Alterego low nasce dalla sensibilità artigianale del designer Giacomo Moor, cui si unisce la capacità di Acerbis di sperimentare e innovare. Una credenza dalle proporzioni generose ma resa sorprendentemente leggera dalla base trasparente e dal sistema di retroilluminazione che creano un effetto di sospensione. Visivamente, il pannello frontale a tutta altezza sembra essere l'unico elemento di supporto, ma è semplicemente una porta scorrevole che rivela gli scomparti interni. Alterego low è dedicata sia al contenimento che all'home entertainment: il vano centrale dotato di ripiani in vetro e fori passacavo consente di accogliere i più moderni sistemi multimediali. Il vano dei cassetti è retroilluminato e può essere dotato di un accessorio portabottiglie da bar in metacrilato opalescente.

Alterego low springs from designer Giacomo Moor's sensitivity for craftsmanship paired with Acerbis' ability to experiment and innovate. The proportions of the credenza are generous, but the almost invisible, transparent base and the glow of the back-lighting create an unusually beautiful optical effect of suspended airiness. Visually, the full-height front panel appears to be the only supporting element, but it's merely a sliding door to the main compartments inside. Alterego low is dedicated both to storage and to home entertainment, designed to accommodate multimedia systems with its central space fitted with glass shelves and holes for cables. The drawer compartment is backlit and can be equipped with an opalescent methacrylate bottle holder bar accessory.

1	Contenitore: laccato lucido rosso mattone LL24.
2	L'effetto sospensione dato dalla base in metacrilato trasparente è enfatizzato da un a di retro-illuminazione.
3	Corpo del mobile chiuso da ante con apertura battente, un grande cassetto estraibile e da un pannello che scorrendo si sovrappone ad esse per svelare un ulteriore vano.

1	Cabinet: glossy lacquered brick red LL24.
2	The suspension effect created by the transparent methacrylate base is emphasized by an back-lighting.
3	The body of the cabinet is closed by hinged doors, a large extractable drawer and by a sliding panel that opens to reveal an additional compartment.



96 Alterego low Credenze Sideboards



97 Acerbis Collection



Alterego low, P.96

1/2 Base: acciaio lucido MT01.  
3 Tavolo con piano sottilissimo, realizzato in materiale composito impiallacciato in varie essenze, oppure in vetro.

1/2 Base: shiny steel MT01.  
3 Table with extra-thin top, made of composite material veneered with precious woods, or in lacquered glass.

# Axis

Design Gabriele & Oscar Buratti

Year 2009

Un design ultra-slim che sorprende costantemente chi lo guarda grazie alle sue forme leggere ed eteree da una parte, o pure e monumentali da un'altra. Axis è una meravigliosa illusione ottica creata dal minimalismo sobrio e vivace, tipico dei designer Gabriele e Oscar Buratti. Il duo, premiato a livello internazionale, ha dato vita a un tavolo caratterizzato da quattro gambe sottili disposte insolitamente con un'angolazione di 90 gradi, che offre effetti ottici che spaziano dalla quasi totale mancanza di peso alla solida stabilità, consentendo allo stesso tempo comodità dei posti a sedere. Il tavolo, con un piano sottilissimo, è realizzato in materiale composito impiallacciato con legni pregiati o in vetro retro-laccato. Il piano è sorretto da quattro gambe in acciaio inossidabile lucidato a specchio o brunito spazzolato, posizionate su assi perpendicolari sfalsati tra loro.

An ultra-slim design, which continually surprises the eye with shapes that are light and airy from one angle, or purified and monumental from another, a marvel of optical illusion created with the simplistic and playful minimalism characteristic of designers Gabriele and Oscar Buratti. The internationally-awarded duo has created a unique table with four slim legs unusually placed at 90 degree angles, resulting in optical effects ranging from near weightlessness to firm stability, while permitting flexible seating arrangements. The table, with an extra-thin top, is made of composite material veneered with precious woods, or in back-lacquered glass. The top is supported by four legs in reflective polished stainless or brushed burnished steel, and placed onto opposite perpendicular axes.

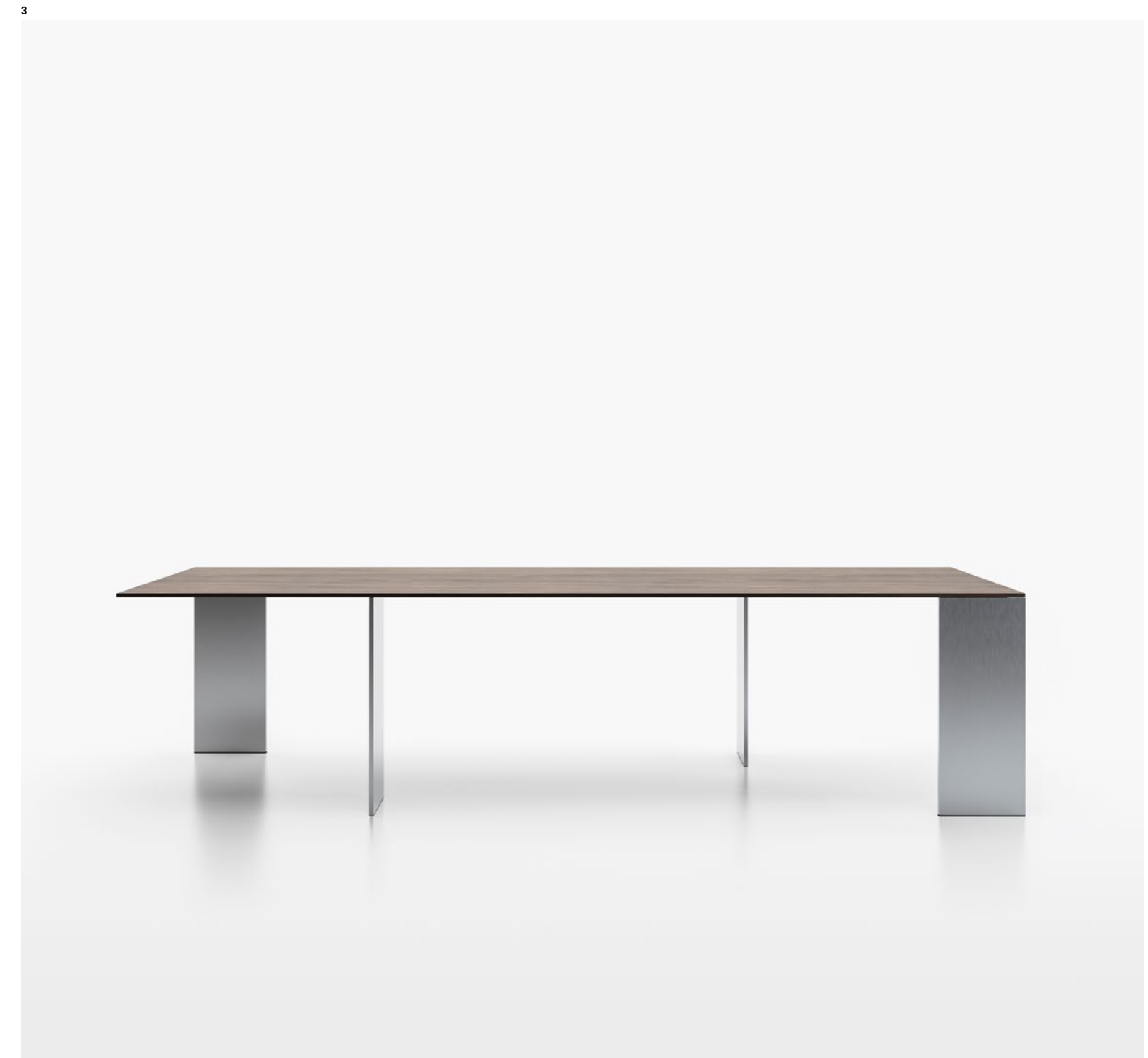



Axis, P.101



- 1 L'apertura del mobile, caratterizzata dal sistema Dual-Flap® in cui la grande anta e una parte del top si aprono simultaneamente.
- 2 Laccato lucido rosso mattone LL24.
- 3 Interno: legno di eucalipto ES48.

- 1 Suspended home-office cabinet. The opening of the unit, characterized by the Dual-Flap® system which the large door and a portion of the top open simultaneously.
- 2 Glossy lacquered brick red LL24.
- 3 Interior: eucalyptus veneer ES48.

# Ghostwriter

Design Giacomo Moor

Year 2017

2018, Big See Product Design Award, Ljubljana

La funzionalità innovativa di Giacomo Moor si manifesta appieno in Ghostwriter, creando una soluzione ideale per l'home office. Un perfetto esempio di minimalismo discreto quando chiuso, con un solo tocco il sistema Dual-Flap® apre l'anta frontale trasformandosi in un pratico tavolo da scrittura. L'interno in legno di eucalipto è uno spazio multifunzionale per l'home office, completato da una luce da scrivania integrata, vani portacarte, cassetto per le penne e, nascoste sul fondo del vano interno, due prese elettriche e USB.

With Ghostwriter, Giacomo Moor's innovative functionality creates the perfect home office. A masterpiece of discreet minimalism when closed, with a single touch the Dual-Flap® system opens the front panel revealing the inside while turning into a handy writing table. The Eucalyptus wood interior is a multi-purpose space for the complete home office with a built-in desk light, paper racks, a drawer for pens, and hidden at the bottom of the inside compartment, plus two respective power and USB outlets.

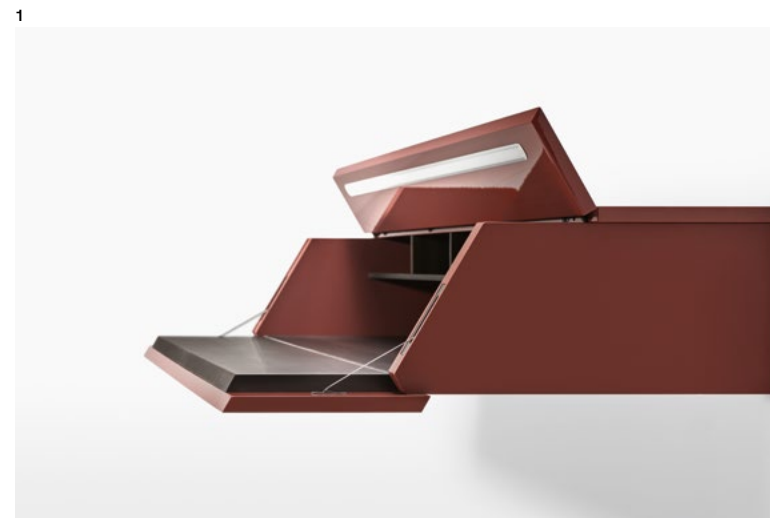



Ghostwriter, P.105

# Grand Buffet

Design	Massimo Castagna
Year	2014

Con Grand Buffet di Massimo Castagna Acerbis reinterpreta la classica credenza conferendole eleganza e praticità, aggiungendo luci LED e favorendo una maggiore accessibilità alla parte posteriore dei vani. Divisa orizzontalmente in due spazi, il vano superiore adotta l'innovativo sistema di apertura Dual-Flap® brevettato da Acerbis: con un tocco il pannello frontale si inclina di 90 gradi, mentre una parte del top si solleva per un accesso più agevole.

With Massimo Castagna's Grand Buffet, Acerbis reinterprets this classic Italian piece with elegance and practicality, adding LED lights and greater accessibility to the back of the compartments. Divided horizontally into two spaces, the upper compartment adopts the evolution of Acerbis' patented and unique Dual-Flap® opening system: one touch tilts the front panel to a 90 degree shelf, while part of the top lifts up for easy access.

- 1 Il vano superiore adotta un'evoluzione dell'innovativo sistema di apertura Dual-Flap®.
- 2 Fondo luminoso in metacrilato opaco con illuminazione a LED con accensione automatica all'apertura dell'anta.
- 3 Laccato lucido verde scuro LL22.

- 1 The upper compartment adopts an evolution of the innovative Dual-Flap® opening system.
- 2 Matt Slate Grey lacquered interior, dividers and back-lit rear panel in matt metacrylate. LED lighting system with automatic switching on at door opening.
- 3 Glossy lacquered dark green LL22.



108 Grand Buffet Credenze Sideboard

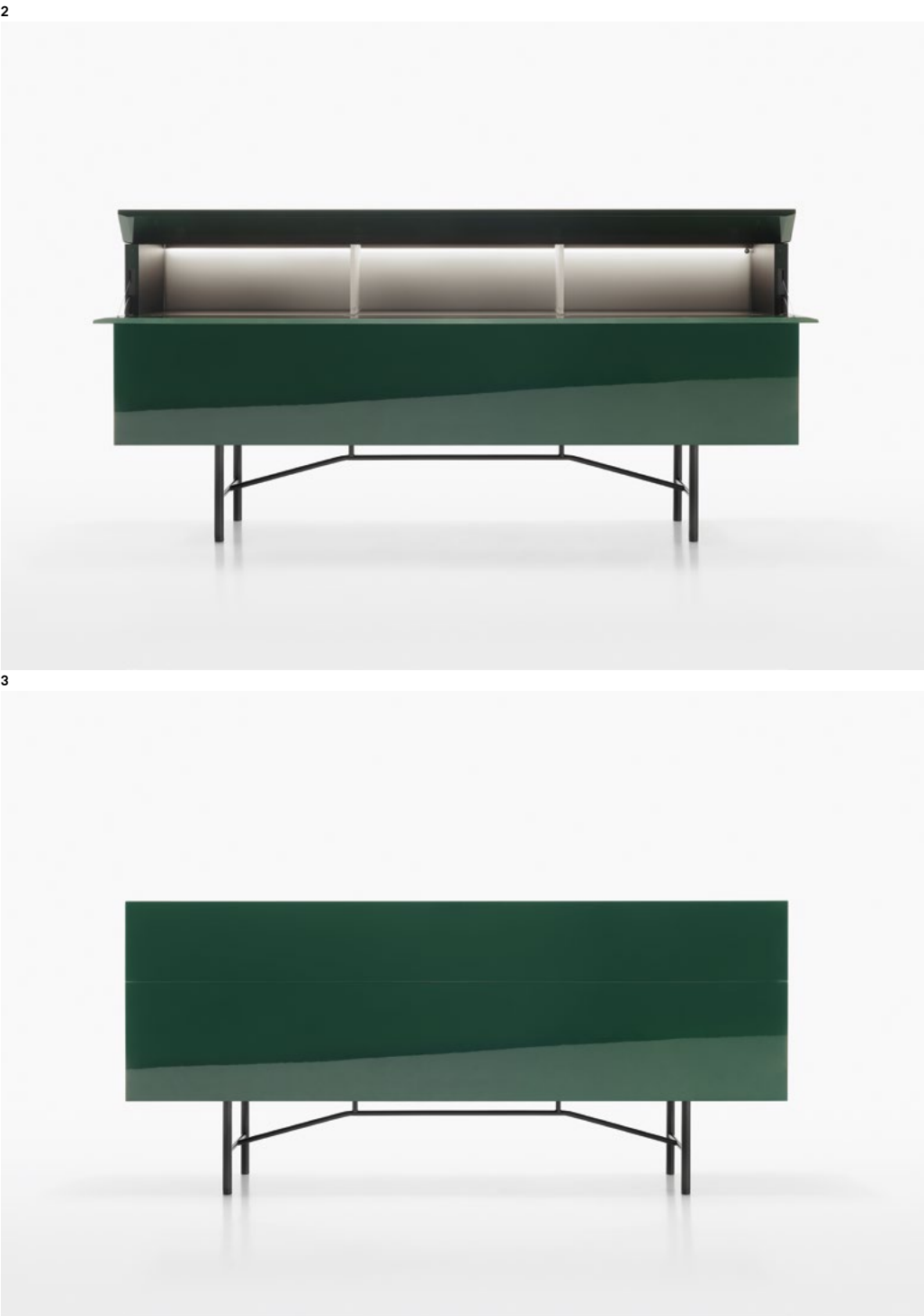

109 Acerbis Collection





1 Judd è un sistema di tavoli che abbina l'essenzialità della forma alla ricchezza dei materiali.  
2/3 I piani sono trasparenti con riquadro centrale sabbiato, spessore 15 mm.

1 Judd is a system of tables that combines an essential line with rich materials.  
2/3 Top in transparent glass with a central sandblasted part, thickness mm 15.



112 Judd Tavoli

# Judd

Design Gabriele & Oscar Buratti

Year 2001

Gabriele e Oscar Buratti hanno creato, con il caratteristico approccio minimalistico che è valso loro un Wallpaper Design Award, la serie di tavoli dalla linea essenziale Judd. Ispirati dai lavori di Donald Judd, questi tavoli sono caratterizzati da un elegante piano in vetro trasparente sorretto da una base rettangolare vuota che, all'esterno, è in acciaio inossidabile lucidato a specchio, mentre all'interno è disponibile in un'ampia gamma di finiture.

Gabriele and Oscar Buratti have, with the characteristic minimalistic approach that earned them a Wallpaper Design Award, created the essential Judd table series. Inspired by Donald Judd's artworks, the tables feature an elegant, transparent glass top supported by a rectangular, hollow table base with a bright polished stainless steel exterior, while the interior is available in a variety of finishes.



113 Acerbis Collection

1/2 Base: acciaio inossidabile lucidato a specchio MT01.  
Top: vetro trasparente extrachiaro VT17.

1/2 Base: bright-polished stainless steel MT01.  
Top: extra-clear transparent glass VT17.

# Litt

Design Gabriele & Oscar Buratti

Year 2002

Gabriele e Oscar Buratti hanno creato una linea di tavolini eleganti e preziosi in acciaio inossidabile lucidato a specchio e vetro, caratterizzati da un intrigante gioco di riflessi e trasparenze. Oltre al suo audace design e bellezza, il tavolino Litt è versatile e pratico, poiché può essere smontato per un facile trasporto.

Gabriele and Oscar Buratti have created a line of elegant and precious low table in bright polished stainless steel and glass, characterized by an intriguing play of reflections and transparency. Apart from the bold design and beauty, the Litt table is versatile and practical as they can be disassembled for easy transport.

2

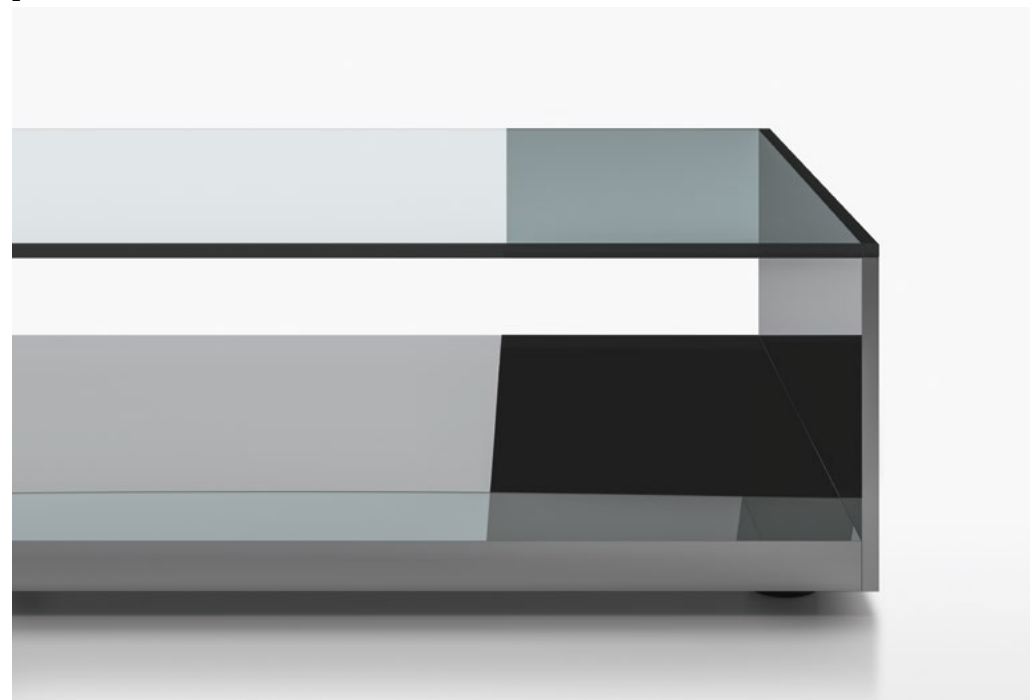

114 Litt Tavolini

Low tables

1



115 Acerbis Collection

# Ludwig

Design	Lodovico Acerbis
Year	2005

Lodovico Acerbis ha creato una credenza iconica che evidenzia la ricerca tecnologica nei sistemi di apertura che da sempre ha contraddistinto l'azienda, rendendo il movimento dell'anta un elemento essenziale di bellezza, un valore aggiunto del design funzionale che si fa estetica e sorpresa. Un volume puro, quasi astratto, caratterizzato dall'assenza di dettagli superflui, che mette in risalto l'eccellenza dei materiali e delle finiture.

Il sistema brevettato Dual-Flap® consente di aprire completamente la grande anta frontale con un semplice gesto, mentre allo stesso tempo il top si solleva per agevolare l'accesso al vano. Una doppia illuminazione, posteriore e frontale, avvolge di luce il mobile, oltre a rischiarare lo spazio interno, concepito con un unico grande vano facilmente fruibile e organizzato tramite due sottili telai di metallo cromato, ripiani in vetro trasparente e cassetti.

Lodovico Acerbis has created an iconic sideboard that perfectly highlights the research of the company in innovative opening systems, that makes the movement of opening an essential element of beauty, to give functional design added aesthetic value so that it becomes a surprise.

The surface of the Ludwig is unadorned with handles or embellishments, instead employing the Dual-Flap® patented system to open the entire front panel with a simple touch while the top simultaneously offers easy access to the anterior areas. A double row of lights illuminates both the exterior and the interior, conceived as a single and easily accessible large compartment organized by two thin chrome-plated metal frames, clear glass shelves, and drawers.

- 1 Mobile caratterizzato dall'innovativo sistema di apertura contemporanea Dual-Flap®, sia dell'anta, sia di una parte del coperchio.
- 2 Laccato lucido bordeaux LL20.
- 3 Telaio interno porta cassetti in metallo cromato lucido. Fianchi esterni e piedi in acciaio inossidabile lucido.

- 1 Sideboard featuring the innovative Dual-Flap® simultaneous opening system for both the door and part of the top.
- 2 Glossy lacquered burgundy LL20.
- 3 Internal frame in shiny chrome-plated metal. External sides in shiny stainless steel. Feet in shiny stainless steel.



116

Ludwig

Credenze

Sideboard



117

Acerbis

Collection



Ludwig, P.116

1 Marmo rosso Levanto opaco MR06.  
2-4 Marmo arabescato bianco opaco MR02.  
5 Marmo verde Alpi opaco MR07.

1 Matt Levanto red marble MR06  
2-4 Matt white arabesque marble MR02.  
5 Matt Alpi Green marble MR07.

2



3



4



5



# Maxwell

Design Massimo Castagna

Year 2014

La forma semplice di Maxwell valorizza la personalità eccezionale delle finiture speciali in pietra che coprono interamente la struttura interna in acciaio, rendendola completamente invisibile. Le venature del marmo, le diverse sfumature dei colori e il mosaico dei minerali – frutto di millenni di processo metamorfico della pietra – sono portati sapientemente alla luce in tutta la loro bellezza. Gli angoli arrotondati e il bordo leggermente rastremato del piano in pietra, in contrasto con le gambe spiccatamente lineari ed angolari, infondono al tavolo un'elegante leggerezza e sono caratteristici dell'approccio personale di Massimo Castagna verso i materiali e i design innovativi.

A simple shape enhances the exceptional personality of the special stone finishes that completely cover the internal steel frame, rendering it invisible. The grains in the marble, the varying shades of colors, and the mosaic of minerals – the result of the millenary process of the metamorphosis of the stone – are skillfully brought to light in all their beauty. The stone table top's rounded corners and slightly tapered edge, in contrast with the distinctly linear and angled legs, imbue the table with an elegant lightness, and is emblematic of Massimo Castagna's approach to materials and innovative designs.

1



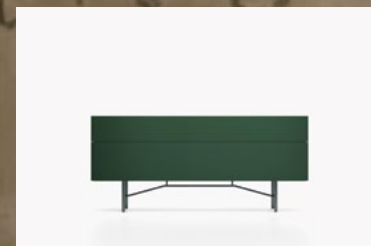

Grand Buffet, P.108

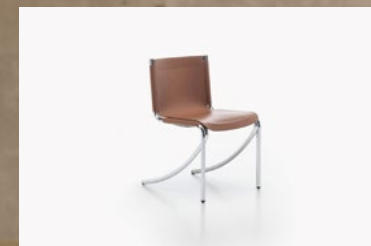

Jot, P.32



1/3 Sistema di tavolini il cui piano è composto accostando liberamente materiali diversi e tra loro in contrasto.  
2 Di forma rettangolare o quadrata, i tavolini possono inoltre essere liberamente accostati tra di loro per comporre tavoli bassi di grande dimensione.

1/3 A system of small tables with a top made by freely combining different contrasting materials.  
2 Rectangular or square, the tables can also be freely combined with each other to form large coffee tables with an ever-changing material and graphic effect.

# Moodboard

Design Massimo Mariani

Year 2018

Nei suoi primi progetti per Acerbis, Massimo Mariani ha applicato il suo approccio orientato ai materiali – che gli è valso il Compasso d'Oro – per creare una linea di tavolini versatili per costruzione e composizione. La collezione Moodboard, composta anche dalla console, è una famiglia di tavolini bassi di diverse dimensioni e forme con piani che combinano differenti materiali – legno, marmo e ottone – creando così un mosaico di materie differenti per tipologia, colore e texture. Un vassoio in acciaio o ottone lucido, facilmente integrabile con gli elementi di cui è composto il tavolino, può essere aggiunto come contenitore svuota tasche o vassoio di servizio. Un elemento che arricchisce il design e la struttura quando non viene utilizzato.

For his first designs for Acerbis, Massimo Mariani applied the materially-focused approach that won him the Compasso d'Oro to create a truly exceptional line of versatile coffee tables of mixed and contrasting materials. Also available as sideboards, the Moodboard collection is a line of low tables in various sizes and shapes, with tops in a mix of wood, marble, polished steel, and brass, creating a mosaic of materials, colors, and textures. Easy to combine to create larger islands of tables for bigger groups, a polished steel or brass tray can be added as a valet or utility tray, which also functions as an integral part of the design and structure when not in use.

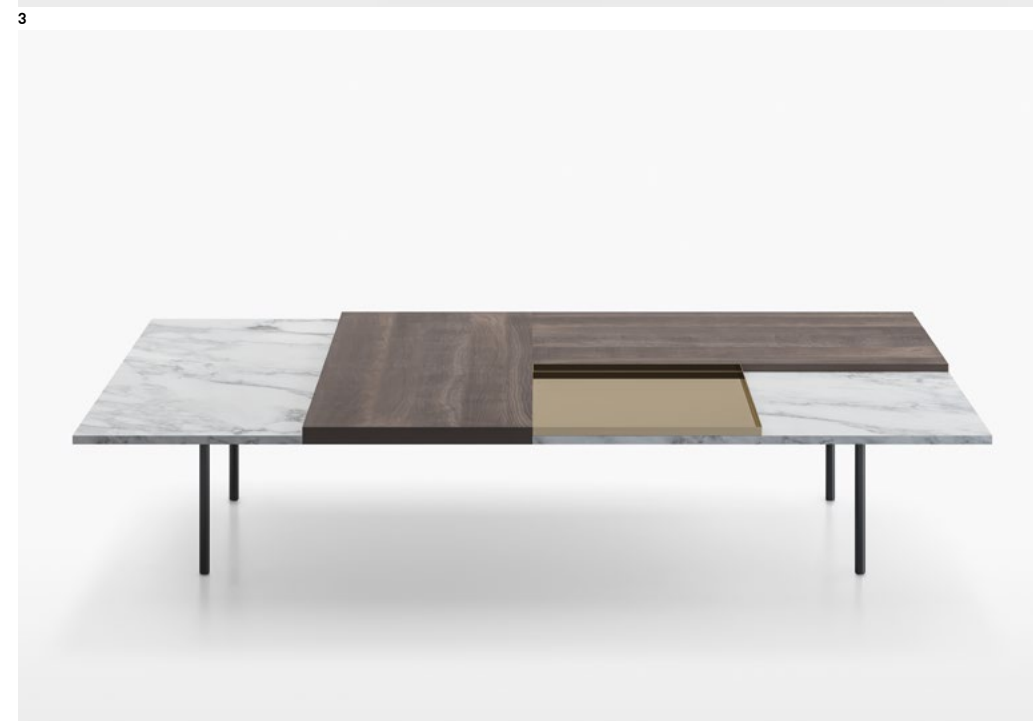
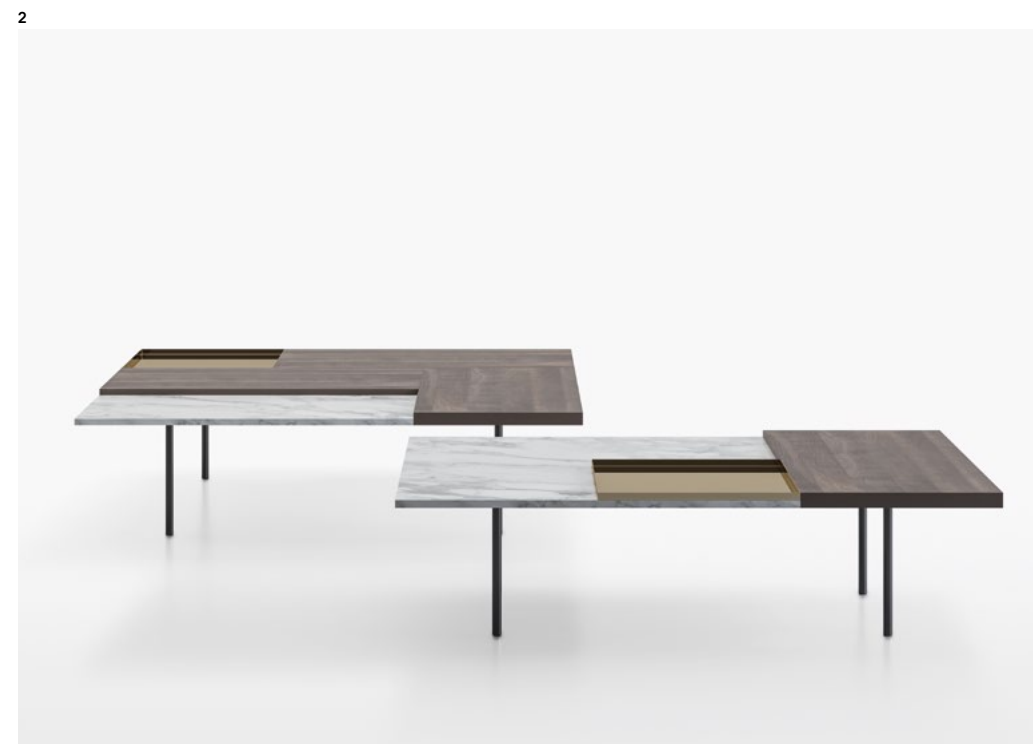

Tavolini

Low tables



125

Acerbis

Collection





Life sofa, P.67



● Storet, P.60 ●



1 Mobile console liberamente componibile appoggiando su una struttura dei volumi e dei piani in materiali diversi e tra loro in contrasto.  
2/3 Un vassoio in metallo lucido, il cui spessore è pensato per integrarsi perfettamente con i diversi spessori dei piani può essere aggiunto come contenitore svuota tasche o vassoio di servizio.

1 Low modular console resting on a structure of volumes and shelves in different contrasting materials.  
2/3 A polished metal tray, the thickness of which is designed to match perfectly with the different thicknesses of the table tops, can be added as a valet or utility tray.

# Moodboard Console

Design Massimo Mariani

Year 2018

L'abile sperimentazione di Massimo Mariani di mixare texture e materiali trova la sua massima espressione nella collezione Moodboard, dove legno, marmo e ottone si combinano tra di loro per creare superfici multimateriale giocose ma allo stesso tempo eleganti. Il piano della credenza bassa può essere personalizzato con una combinazione di materiali in continuità o in contrasto con i contenitori. Un vassoio in acciaio lucido o in ottone, che funziona anche come parte integrante del design quando non è in uso, può essere aggiunto come elemento di servizio.

The skillful experiments with textures and shades of Massimo Mariani's Moodboard coffee tables and sideboards gracefully mixes wood, brass, and marble to create a playful yet elegant multi-material surface. The low sideboard can be personalized with a combination of top materials, and a polished steel or brass tray can be added as a valet or utility tray, which also functions as an integral part of the design and structure when not in use.

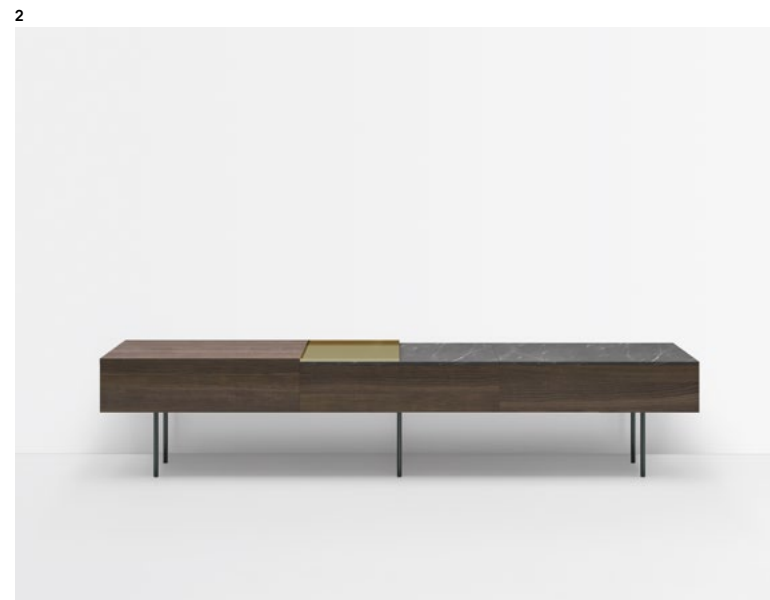

128 Moodboard Console



Credenze Sideboard



129 Acerbis Collection



Moodboard Console, P.129



# NC Sideboard

Design	Lodovico Acerbis
Year	1999

Questa linea di mobili apparentemente sospesi, quintessenza dell'ingegno di Lodovico Acerbis, è immersa nella luce grazie al sistema di retroilluminazione. La luce, diffusa attraverso una fascia di metacrilato opaco posta nella parte posteriore, nell'interno e alla base della credenza, offre un effetto ottico di totale assenza di peso, accentuato dalla semitrasparenza della base in metacrilato opaco del vano contenitore.

Lodovico Acerbis' quintessential line of seemingly suspended furniture is bathed in illumination by its clever back-lighting system. The light, diffused through a strip of matte methacrylate in the rear, interior, and base of the sideboard, offers an optical effect of weightlessness, heightened by the semi-transparency of the matte methacrylate base of the cabinet.

1 Laccato lucido nero LL06.  
2 Famiglia di credenze caratterizzate da un sistema di illuminazione, posto in una fascia tecnica posteriore, che permette il passaggio cavi e la diffusione della luce.

1 Glossy lacquered black LL06.  
2 Family of sideboards characterised by a lighting system placed in a rear strip that houses the cables and enables the light to be diffused simultaneously from the upper part.



132 NC Sideboard Credenze Sideboard



133 Acerbis Collection

1 Libreria autoportante, da parete o da centro, in cui aerei piani e volumi in legno di diverse dimensioni dialogano con un reticolo metallico rigoroso in modo da creare un paesaggio irregolare.  
 2-4 Struttura: acciaio satinato verniciato nichel nero MT05.

1 A freestanding bookcase, which can be placed against the wall or in the center of the room. The various elements can be inserted simply by sliding the round profiles of the metal structure into the unusual round.  
 2-4 Structure: satin steel - black nickel painted MT05.

# Outline

Design Giacomo Moor  
 Year 2016

Con Outline, Giacomo Moor ha creato una libreria elegante e funzionale composta da contenitori e mensole in legno in contrasto con il telaio in metallo, che può essere posizionata a parete o al centro della stanza. Gli inusuali incavi rotondi di fissaggio rompono la linearità del design e permettono di inserire i componenti a piacimento, facendoli scorrere facilmente dentro e fuori quando si riorganizzano. Il contrasto tra i volumi dei contenitori e delle mensole con la leggerezza della struttura coniuga l'impatto visivo contemporaneo con quello di un mobile artigianale.

With Outline, Giacomo Moor has created an elegantly functional, freestanding system of wooden cabinets and shelves contrasted with an iron support structure that can be placed against a wall or in the center of a space. The unusual round attachment recesses in the shelves and the cabinets break the linearity of the design and allow the components to be inserted by preference, easily sliding them in and out of place when rearranging. The visual contrast between the dimensions of the cabinets and shelves, and the lightness of the structure, unites the contemporary visual impact with that of a handmade cabinet.

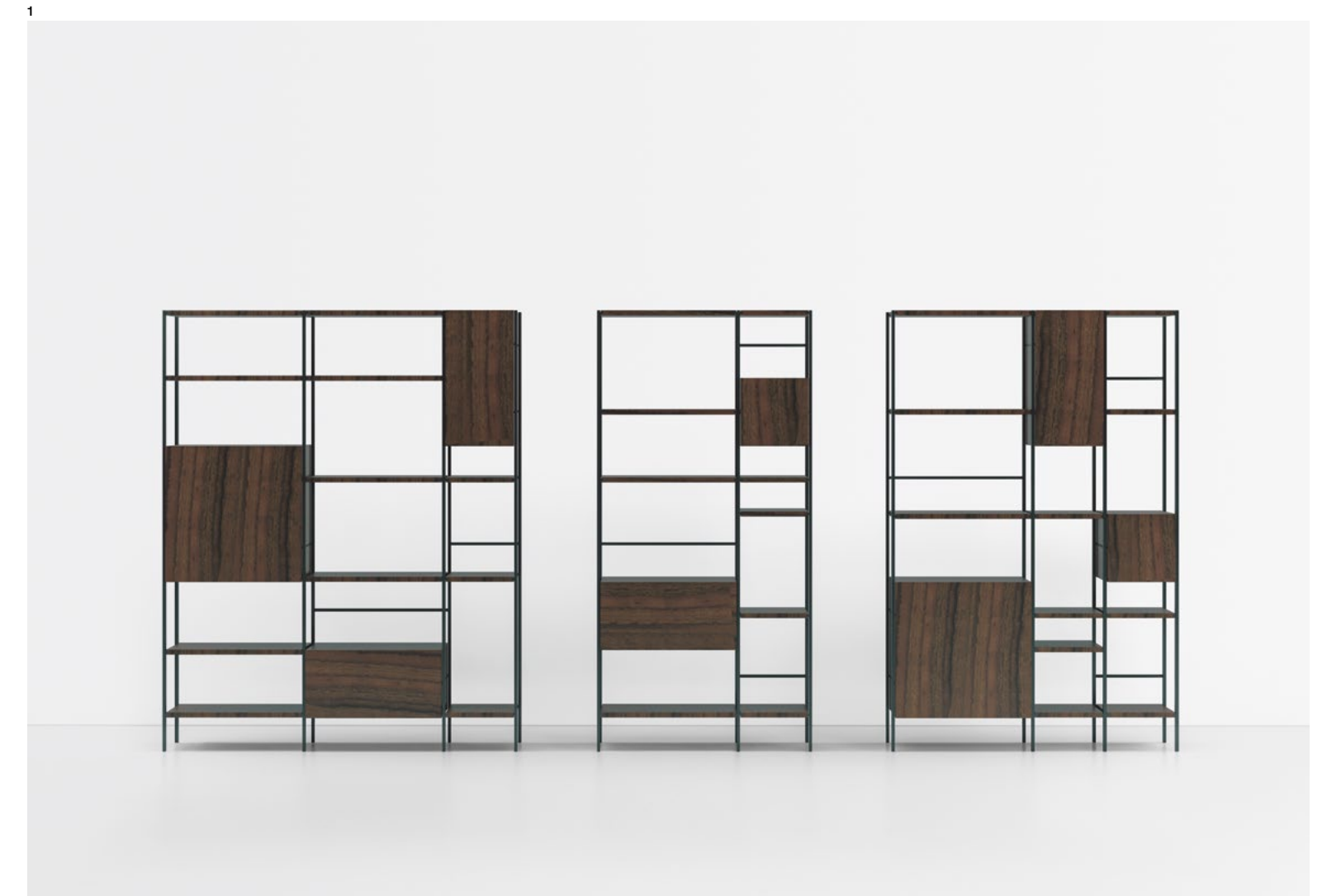



1 Top: marmo bianco arabescato MR02, rosso Levanto MR06 o verde Alpi MR07.  
2 Base in poliuretano BAYDUR®60 stampato, laccato lucido disponibile nei colori: nero, bianco, bianco SW, lino, sabbia, argilla, bordeaux, rosa, verde scuro, giallo senape, rosso mattone, blu navy.

1 Top: White Arabesque marble MR02, Levanto red marble MR06 o Alpi green MR07.  
2 Base in molded polyurethane BAYDUR®60 glossy lacquer available in: black, white, white SW, linen, sand, clay, burgundy, pink, dark green, mustard yellow, brick red, navy blue.

# Pond

Design Marco Acerbis

Year 2006

Rivisitazione giocosa e vivace dei complementi del salotto italiano per eccellenza, la famiglia di tavolini Pond è caratterizzata da una base conica che sembra scomparire nell'ombra. La superficie in vetro lucido crea l'illusione di una specchio d'acqua, mentre le finiture in pietra affascinano per la ricchezza delle venature e il mosaico di materiali di cui sono composte. Facilmente adattabili a vari spazi, i tavolini sono disponibili in tre misure e altezze, con una versione da 120 cm su ruote rimovibili nascoste all'interno della base.

A playful and spirited re-imagination of quintessential Italian living room pieces, the Pond family of cocktail and side tables, with a conical base that seems to disappear into shadow, creates an illusion of a watery surface in high-gloss glass, or intrigues with the mosaic of minerals and grains of the marble top. Easily adaptable to various spaces, the tables come in a range of measurements, with a 120 cm version on removable wheels which are hidden inside the base.



138

Pond

Tavolini

Low tables



139

Acerbis

Collection

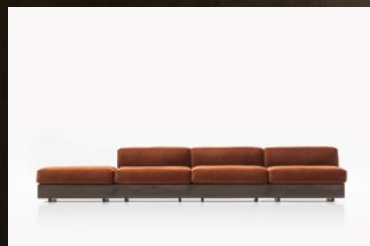

Life sofa, P.67





1 Fianchi esterni in acciaio inossidabile lucidato a specchio.  
2 Laccato lucido rosso mattone LL24.  
3 Laccato lucido argilla LL15.

1 Side panels in mirror polished stainless steel.  
2 Glossy lacquered brick red LL24.  
3 Glossy lacquered clay LL15

# Steel

Design Lodovico Acerbis, Gabriele & Oscar Buratti

Year 2001

Una credenza che nasce dalla collaborazione unica tra il pluripremiato designer Gabriele Buratti e lo stesso Lodovico Acerbis. Steel è caratterizzata da dimensioni generose e la sua struttura minimalista è enfatizzata dai fianchi esterni in acciaio lucidato a specchio. Una fascia in metacrilato opaco inserita nel top diffonde la luce contemporaneamente nella parte superiore, inferiore e all'interno.

In a unique collaboration, award-winning designer Gabriele Buratti and Acerbis' own Lodovico Acerbis created this unusually wide sideboard, emphasized by a minimalist structure that rests on two ephemerally thin side panels in mirror-polished steel, and bathed in light diffused by a matte methacrylate strip set into the top, with an illuminated interior and base as well.

2



3

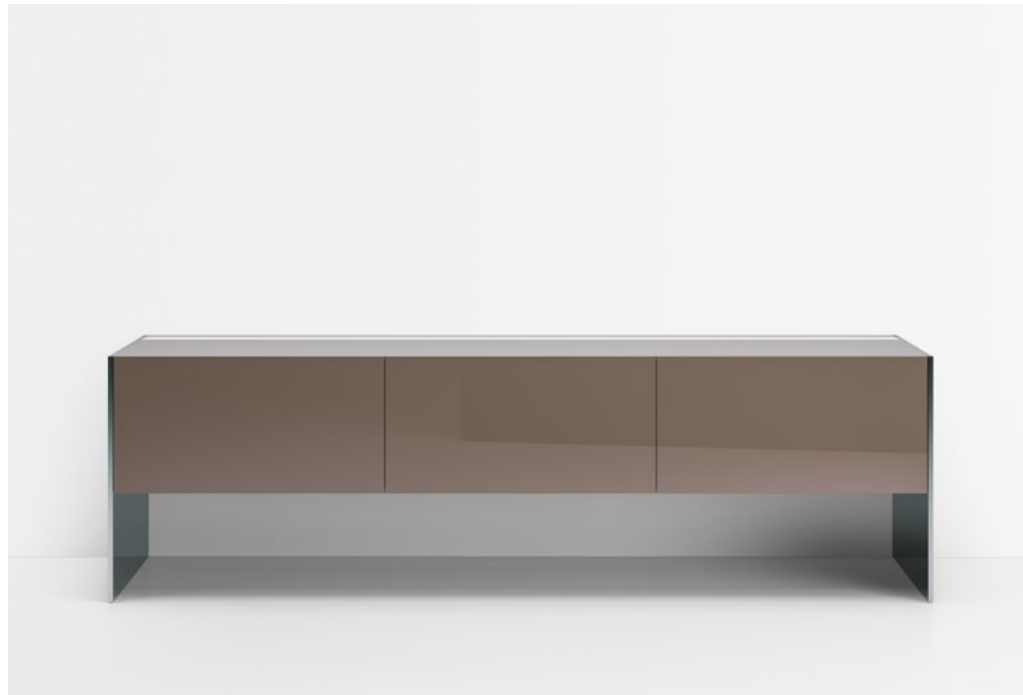

1

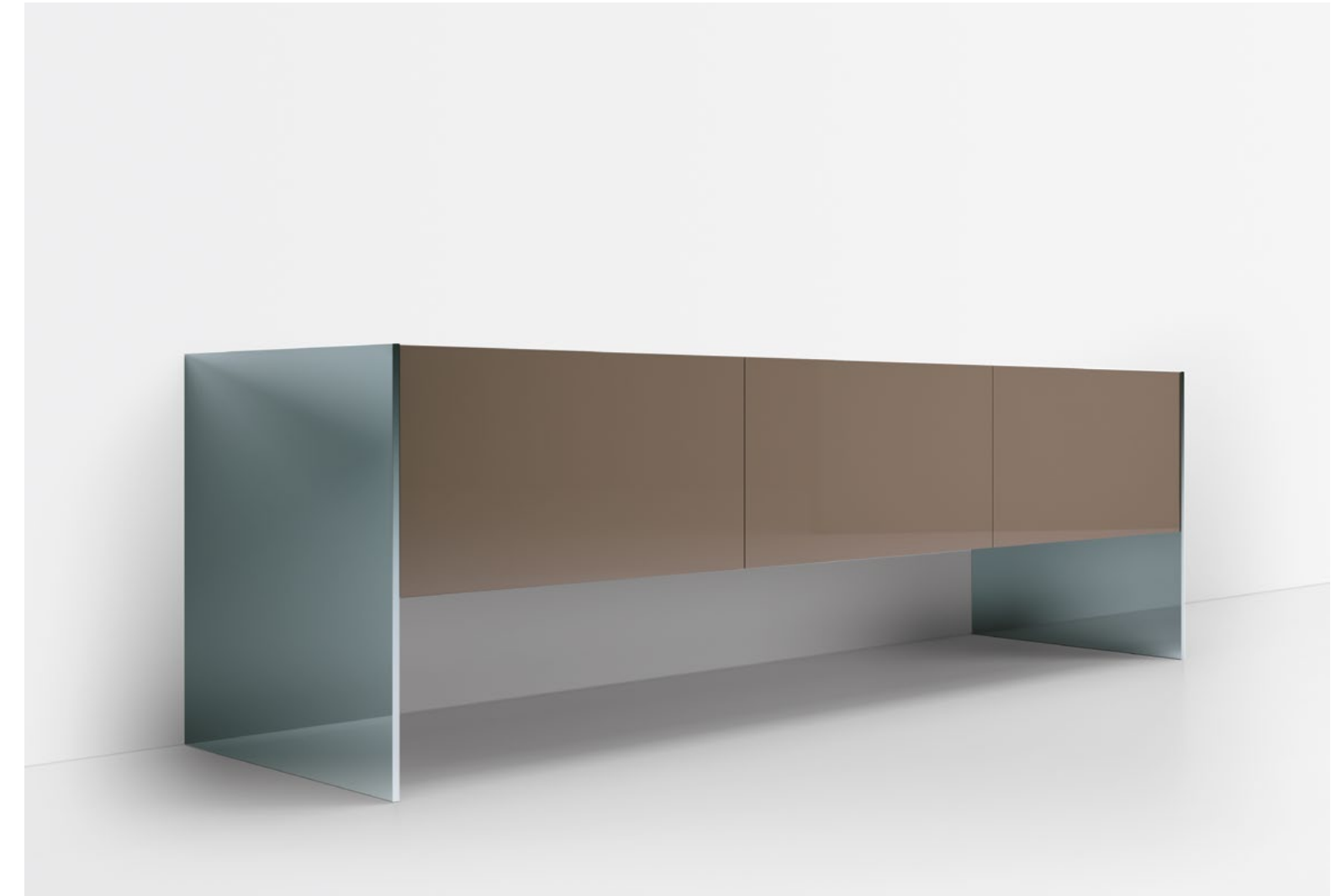

---

# Informazioni tecniche

---

# Technical information

Alterego	146
Alterego low	147
Axis	148
Creso	149
Florian	150
Ghostwriter	151
Gong	152
Grand Buffet	153
Jot	154
Judd	155
Life sofa	156
Life system	157
Litt	158
Ludwig	159
Maestro	160
Maxwell	161
Med	162
Menhir	163
Moodboard	164
Moodboard Console	165
NC Sideboard	166
Outline	167
Pond	168
Serenissimo	169
Sheraton	171
Spiros	172
Steel	173
Storet	174

A

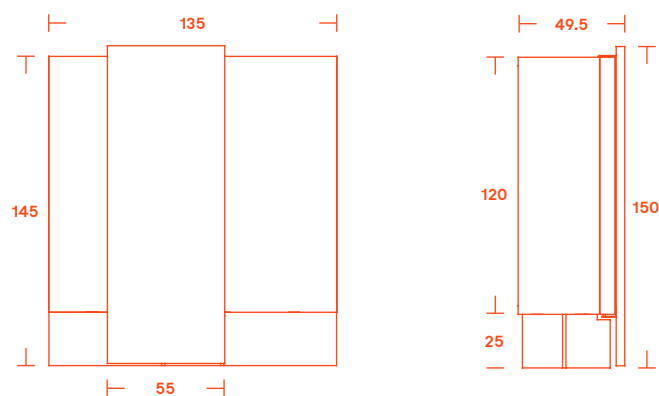

Dimensioni/Dimensions  
L135  
D49.5  
H150

B

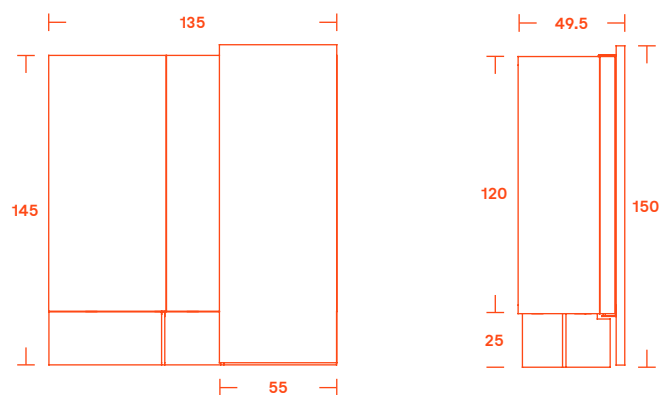

Dimensioni/Dimensions  
L135  
D49.5  
H150

Struttura (contenitore e ante battenti)	
Laccato bordeaux lucido o opaco	LL20 / LO88
Laccato rosa lucido o opaco	LL21 / LO89
Laccato verde scuro lucido o opaco	LL22 / LO90
Laccato giallo senape lucido o opaco	LL23 / LO91
Laccato rosso mattone lucido o opaco	LL24 / LO92
Laccato bianco SW lucido o opaco	LL09 / LO74
Laccato argilla lucido o opaco	LL15 / LO81
Laccato nero lucido o opaco	LL06 / LO72
Laccato sabbia lucido o opaco	LL12 / LO76
Laccato lino lucido o opaco	LL10 / LO75
Laccato bianco lucido o opaco	LL02 / LO73
Laccato blu navy lucido o opaco	LL25 / LO93
Frassino palude	ES57
Eucalpto	ES48
Eucalpto nero	ES47
Noce tinto scuro	ES59

Anta scorrevole	
Laccato lucido bordeaux	LL20
Laccato lucido rosa	LL21
Laccato lucido verde scuro	LL22
Laccato lucido giallo senape	LL23
Laccato lucido rosso mattone	LL24
Laccato lucido bianco SW	LL09
Laccato lucido argilla	LL15
Laccato lucido nero	LL06
Laccato lucido sabbia	LL12
Laccato lucido lino	LL10
Laccato lucido bianco	LL02
Laccato lucido blu navy	LL25
Laccato opaco metallizzato - nichel 15 spazzolato	LMO90
Terre Vulcaniche marrone Vesuvio	TV02
Terre Vulcaniche grigio Etna	TV01
Terre Vulcaniche bianco Lipari	TV03

Base	
Metacrilato trasparente	

Contenitore e ante/Cabinet and doors			
LL20 / LO88	LL21 / LO89	LL22 / LO90	LL23 / LO91
LL24 / LO92	LL09 / LO74	LL15 / LO81	LL06 / LO72
LL12 / LO76	LL10 / LO75	LL02 / LO73	LL25 / LO93
ES57	ES48	ES47	ES59
LMO90	TV02	TV01	TV03

Structure (cabinet and hinged doors)	
Glossy or matt lacquered burgundy	LL20 / LO88
Glossy or matt lacquered pink	LL21 / LO89
Glossy or matt lacquered dark green	LL22 / LO90
Glossy or matt lacquered mustard yellow	LL23 / LO91
Glossy or matt lacquered brick red	LL24 / LO92
Glossy or matt lacquered SW white	LL09 / LO74
Glossy or matt lacquered clay	LL15 / LO81
Glossy or matt lacquered black	LL06 / LO72
Glossy or matt lacquered sand	LL12 / LO76
Glossy or matt lacquered linen	LL10 / LO75
Glossy or matt lacquered white	LL02 / LO73
Glossy or matt lacquered Navy blue	LL25 / LO93
Swamp ash	ES57
Eucalyptus	ES48
Black eucalyptus	ES47
Dark stained walnut	ES59

Sliding door	
Glossy lacquered burgundy	LL20
Glossy lacquered pink	LL21
Glossy lacquered dark green	LL22
Glossy lacquered mustard yellow	LL23
Glossy lacquered brick red	LL24
Glossy lacquered SW white	LL09
Glossy lacquered clay	LL15
Glossy lacquered black	LL06
Glossy lacquered sand	LL12
Glossy lacquered linen	LL10
Glossy lacquered white	LL02
Glossy lacquered Navy blue	LL25
Brushed metallic nickel 15 - matt lacquered	LMO90
Volcanic earth Vesuvio brown	TV02
Volcanic earth Etna grey	TV01
Volcanic earth Lipari white	TV03

Base	
Transparent methacrylate	

Dimensioni/Dimensions  
L246  
D49.5  
H65

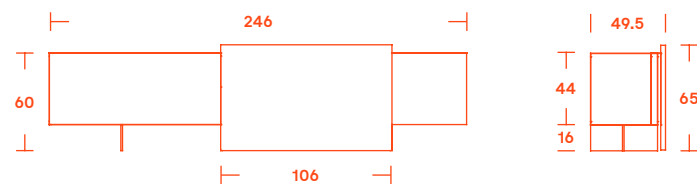

Dimensioni/Dimensions  
L290  
D49.5  
H65

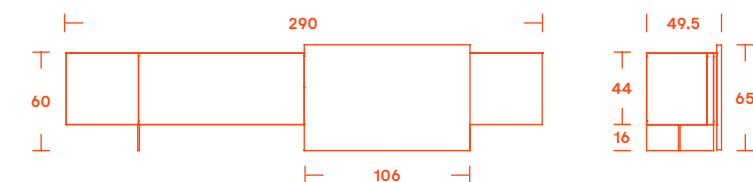

Struttura (contenitore e ante battenti)		Structure (cabinet and hinged doors)	
Laccato bordeaux lucido o opaco	LL20 / LO88	Glossy or matt lacquered burgundy	LL20 / LO88
Laccato rosa lucido o opaco	LL21 / LO89	Glossy or matt lacquered pink	LL21 / LO89
Laccato verde scuro lucido o opaco	LL22 / LO90	Glossy or matt lacquered dark green	LL22 / LO90
Laccato giallo senape lucido o opaco	LL23 / LO91	Glossy or matt lacquered mustard yellow	LL23 / LO91
Laccato rosso mattone lucido o opaco	LL24 / LO92	Glossy or matt lacquered brick red	LL24 / LO92
Laccato bianco SW lucido o opaco	LL09 / LO74	Glossy or matt lacquered SW white	LL09 / LO74
Laccato argilla lucido o opaco	LL15 / LO81	Glossy or matt lacquered clay	LL15 / LO81
Laccato nero lucido o opaco	LL06 / LO72	Glossy or matt lacquered black	LL06 / LO72
Laccato sabbia lucido o opaco	LL12 / LO76	Glossy or matt lacquered sand	LL12 / LO76
Laccato lino lucido o opaco	LL10 / LO75	Glossy or matt lacquered linen	LL10 / LO75
Laccato bianco lucido o opaco	LL02 / LO73	Glossy or matt lacquered white	LL02 / LO73
Laccato blu navy lucido o opaco	LL25 / LO93	Glossy or matt lacquered Navy blue	LL25 / LO93
Frassino palude	ES57	Swamp ash	ES57
Eucalpto	ES48	Eucalyptus	ES48
Eucalpto nero	ES47	Black eucalyptus	ES47
Noce tinto scuro	ES59	Dark stained walnut	ES59

Anta scorrevole		Sliding door	
Laccato lucido bordeaux	LL20	Glossy lacquered burgundy	LL20
Laccato lucido rosa	LL21	Glossy lacquered pink	LL21
Laccato lucido verde scuro	LL22	Glossy lacquered dark green	LL22
Laccato lucido giallo senape	LL23	Glossy lacquered mustard yellow	LL23
Laccato lucido rosso mattone	LL24	Glossy lacquered brick red	LL24
Laccato lucido bianco SW	LL09	Glossy lacquered SW white	LL09
Laccato lucido argilla	LL15	Glossy lacquered clay	LL15
Laccato lucido nero	LL06	Glossy lacquered black	LL06
Laccato lucido sabbia	LL12	Glossy lacquered sand	LL12
Laccato lucido lino	LL10	Glossy lacquered linen	LL10
Laccato lucido bianco	LL02	Glossy lacquered white	LL02
Laccato lucido blu navy	LL25	Glossy lacquered Navy blue	LL25
Laccato opaco metallizzato - nichel 15 spazzolato	LMO90	Brushed metallic nickel 15 - matt lacquered	LMO90
Terre Vulcaniche marrone Vesuvio	TV02	Volcanic earth Vesuvio brown	TV02
Terre Vulcaniche grigio Etna	TV01	Volcanic earth Etna grey	TV01
Terre Vulcaniche bianco Lipari	TV03	Volcanic earth Lipari white	TV03

Base		Base	
Metacrilato trasparente		Transparent methacrylate	

Contenitore e ante/Cabinet and doors			
LL20 / LO88	LL21 / LO89	LL22 / LO90	LL23 / LO91
LL24 / LO92	LL09 / LO74	LL15 / LO81	LL06 / LO72
LL12 / LO76	LL10 / LO75	LL02 / LO73	LL25 / LO93
ES57	ES48	ES47	ES59
LMO90	TV02	TV01	TV03

# Axis

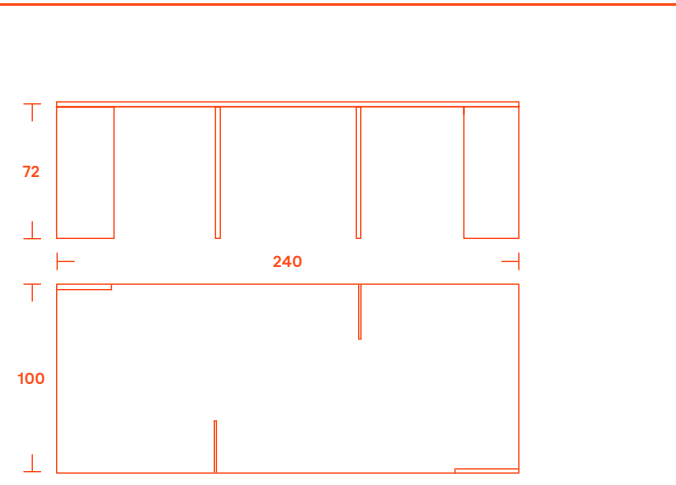

Dimensioni/Dimensions  
L240  
D100  
H72

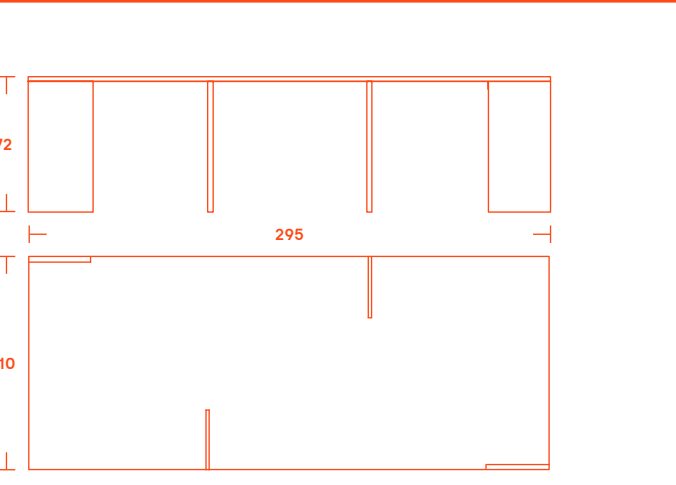

Dimensioni/Dimensions  
L295  
D110  
H72

Top		Top	
Eucalipto nero	ES47	Black eucalyptus	ES47
Eucalipto	ES48	Eucalyptus	ES48
Frassino palude	ES57	Swamp ash	ES57
Noce tinto scuro	ES59	Dark stained walnut	ES59
Cristallo laccato bianco	VT01	White lacquered glass	VT01
Cristallo frosted laccato bianco	VT02	White lacquered frosted glass	VT02
Cristallo laccato grigio caldo	VT04	Warm grey lacquered glass	VT04
Cristallo laccato nero	VT03	Black lacquered glass VT03	VT03
Base		Base	
Acciaio lucido	MT01	Shiny steel MT01	MT01
Acciaio brunito spazzolato - verniciato lucido	MT02	Burnished brushed steel - glossy painted	MT02

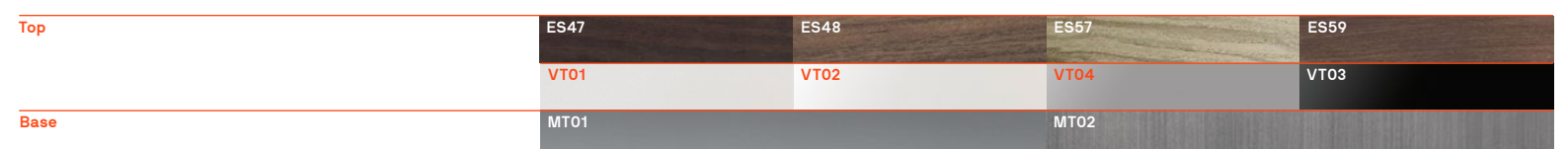

# Creso

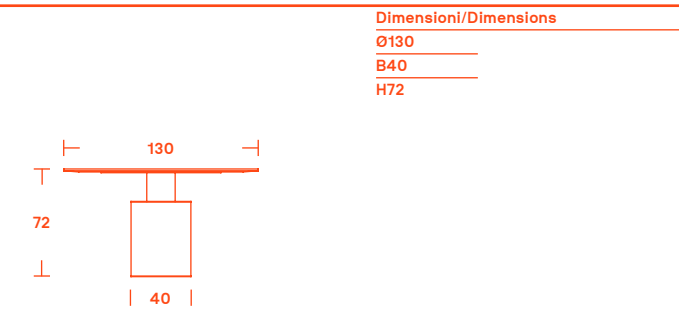

Dimensioni/Dimensions  
Ø130  
B40  
H72

Top  
Cristallo/Glass  
Marmo/Marble

Base  
Acciaio/Steel  
Verniciato/Painted  
Marmo/Marble\*

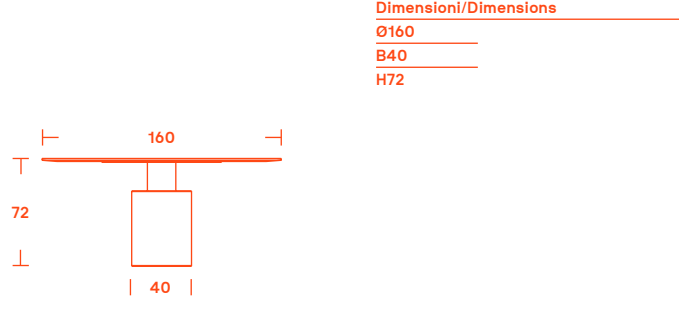

Dimensioni/Dimensions  
Ø160  
B40  
H72

Top  
Cristallo/Glass  
Marmo/Marble

Base  
Acciaio/Steel  
Verniciato/Painted  
Marmo/Marble

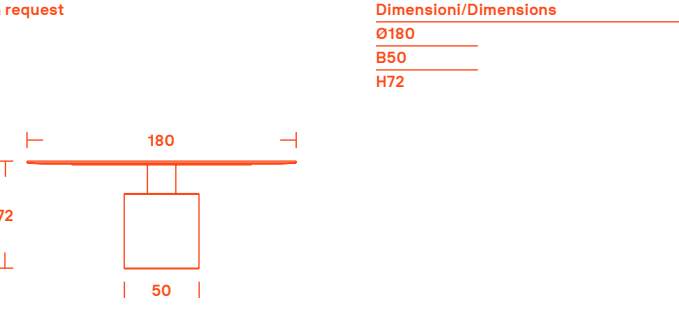

On request

Dimensioni/Dimensions  
Ø180  
B50  
H72

Top  
Cristallo/Glass  
Marmo/Marble\*

Base  
Acciaio/Steel  
Verniciato/Painted  
Marmo/Marble

Top		Base	
Cristallo trasparente	VT17	Acciaio lucido ottonato	MT03
Marmo arabescato bianco opaco	MR02	Verniciato opaco canna di fucile	MT13
Marmo nero Marquinia opaco	MR05	Verniciato opaco bronzo orbitale	MT14
Marmo rosso Levanto opaco	MR06	Marmo travertino opaco**	MR08
Marmo verde Alpi opaco	MR07		
Marmo travertino opaco**	MR08		
Top		Base	
Transparent glass	VT17	Satin polished steel - brass effect	MT03
White arabesque marble matt or glossy	MR02	Matt painted gunmetal	MT13
Marquinia black marble	MR05	Matt painted orbital bronze	MT14
Levanto red marble	MR06	Matt travertino marble**	MR08
Alpi Green marble	MR07		
Matt travertino marble**	MR08		

\*Solo per top in marmo MR02, MR05, MR06, MR07 e top in cristallo VT17.  
\*\*Solo abbinamento monomaterico  
\*Only for marble tops MR02, MR05, MR06, MR07 and glass top VT17.  
\*\*Only monomateric combinations

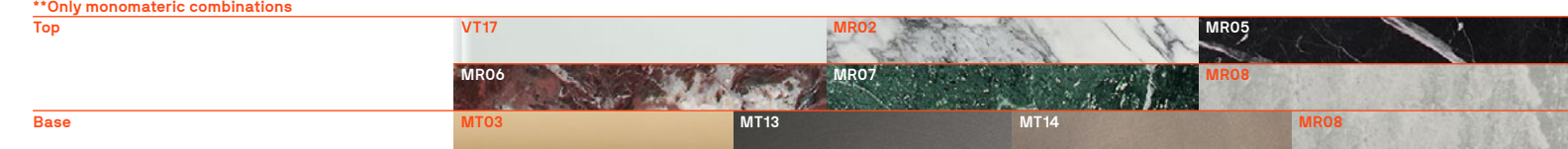

## Florian

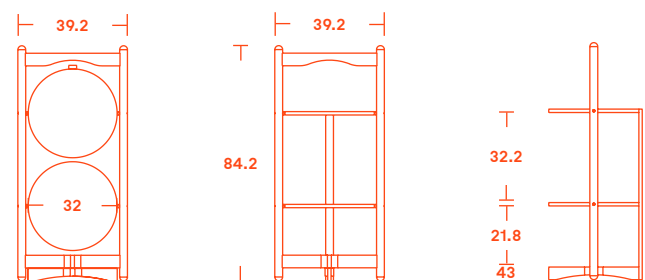

Dimensioni/Dimensions	Finiture/Finishes
L39.2	Frassino/Ash
D39.2	Laccato/Glossy
H84.2	

Finiture		
	Frassino nero	ES58
	Laccato verde scuro	LL22
	Laccato giallo senape	LL23
	Laccato rosso mattone	LL24

Finishes		
	Black ash	ES58
	Glossy lacquered dark green	LL22
	Glossy lacquered mustard yellow	LL23
	Glossy lacquered brick red	LL24

## Ghostwriter

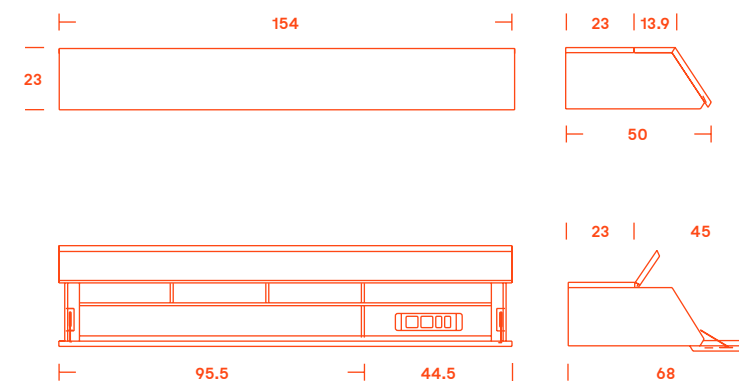

Dimensioni/Dimensions
L154
D50
H23

Anta e top	Door and top		
Laccato lucido bordeaux	LL20	Glossy lacquered burgundy	LL20
Laccato lucido rosa	LL21	Glossy lacquered pink	LL21
Laccato lucido verde scuro	LL22	Glossy lacquered dark green	LL22
Laccato lucido giallo senape	LL23	Glossy lacquered mustard yellow	LL23
Laccato lucido rosso mattone	LL24	Glossy lacquered brick red	LL24
Laccato lucido bianco SW	LL09	Glossy lacquered SW white	LL09
Laccato lucido argilla	LL15	Glossy lacquered clay	LL15
Laccato lucido nero	LL06	Glossy lacquered black	LL06
Laccato lucido sabbia	LL12	Glossy lacquered sand	LL12
Laccato lucido lino	LL10	Glossy lacquered linen	LL10
Laccato lucido bianco	LL02	Glossy lacquered white	LL02
Laccato lucido blu navy	LL25	Glossy lacquered Navy blue	LL25
Interno	Interior		
Eucalipto	ES48	Eucalyptus	ES48

Finiture/Finishes	ES58	LL22	LL23	LL24

Anta e top/Door and top	LL20	LL21	LL22	LL23
	LL24	LL09	LL15	LL06
	LL12	LL10	LL02	LL25
Interno/Interior	ES48			

## Gong



### Dimensioni/Dimensions

Ø27  
H80

### Stelo/Stem

Stelo verniciato/Painted stem  
Stelo ottone/Brass stem



### Dimensioni/Dimensions

Ø43  
H45

### Stelo/Stem

Stelo verniciato/Painted stem  
Stelo ottone/Brass stem



### Dimensioni/Dimensions

Ø43  
H55

### Stelo/Stem

Stelo verniciato/Painted stem  
Stelo ottone/Brass stem



### Dimensioni/Dimensions

Ø55  
H35

### Stelo/Stem

Stelo verniciato/Painted stem  
Stelo ottone/Brass stem

Top	Stelo
Verniciato opaco canna di fucile MT13	Verniciato opaco canna di fucile MT13
Verniciato opaco bronzo orbitale MT14	Verniciato opaco bronzo orbitale MT14
	Ottone spazzolato MT15
Top	Stem
Matt painted gunmetal MT13	Matt painted gunmetal MT13
Matt painted orbital bronze MT14	Matt painted orbital bronze MT14
	Brushed brass MT15

La differenza tra i tavolini della stessa finitura è caratteristica della lavorazione manuale che può essere suscettibile a variazioni di tonalità e omogeneità.  
The difference between the coffee tables of the same finish is characteristic of the manual processing that can be susceptible to variations in tone and homogeneity.

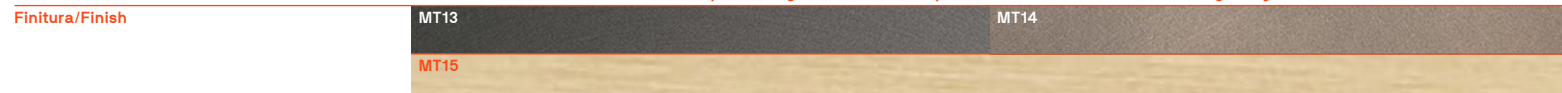

## Grand Buffet

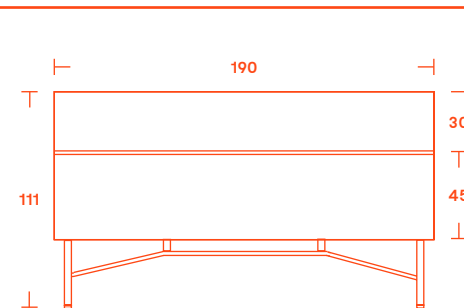

### Dimensioni/Dimensions

L190  
D48  
H111

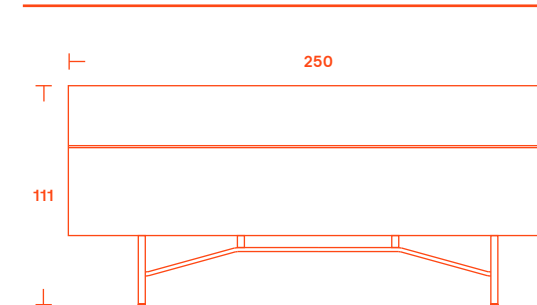
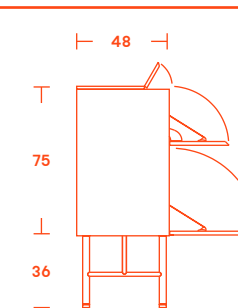

### Dimensioni/Dimensions

L250  
D48  
H111

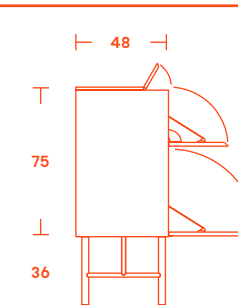

Ante e top	Doors and top
Laccato bordeaux lucido o opaco LL20 / LO88	Glossy or matt lacquered burgundy LL20 / LO88
Laccato rosa lucido o opaco LL21 / LO89	Glossy or matt lacquered pink LL21 / LO89
Laccato verde scuro lucido o opaco LL22 / LO90	Glossy or matt lacquered dark green LL22 / LO90
Laccato giallo senape lucido o opaco LL23 / LO91	Glossy or matt lacquered mustard yellow LL23 / LO91
Laccato rosso mattone lucido o opaco LL24 / LO92	Glossy or matt lacquered brick red LL24 / LO92
Laccato bianco SW lucido o opaco LL09 / LO74	Glossy or matt lacquered SW white LL09 / LO74
Laccato argilla lucido o opaco LL15 / LO81	Glossy or matt lacquered clay LL15 / LO81
Laccato nero lucido o opaco LL06 / LO72	Glossy or matt lacquered black LL06 / LO72
Laccato sabbia lucido o opaco LL12 / LO76	Glossy or matt lacquered sand LL12 / LO76
Laccato lino lucido o opaco LL10 / LO75	Glossy or matt lacquered linen LL10 / LO75
Laccato bianco lucido o opaco LL02 / LO73	Glossy or matt lacquered white LL02 / LO73
Laccato blu navy lucido o opaco LL25 / LO93	Glossy or matt lacquered Navy blue LL25 / LO93
Eucalpto ES48	Eucalyptus ES48
Eucalpto nero ES47	Black eucalyptus ES47

Base	Base
Verniciato grigio micaceo	Micaceous grey painted

Contenitore in essenza: interni laccati grigio ardesia opaco con divisori in metacrilato opaco.  
Veneer cabinet: matt slate grey lacquered interior, dividers and back-lit rear panel in matt methacrylate.  
Contenitore laccato: interni in laccato opaco in tinta con gli esterni.  
Lacquered cabinet: matt slate lacquered interior, matching the exterior.

Contenitore e ante/Cabinet and doors	LL20 / LO88	LL21 / LO89	LL22 / LO90	LL23 / LO91
	LL24 / LO92	LL09 / LO74	LL15 / LO81	LL06 / LO72
	LL12 / LO76	LL10 / LO75	LL02 / LO73	LL25 / LO93
	ES48		ES47	
Telaio/Frame				

## Jot

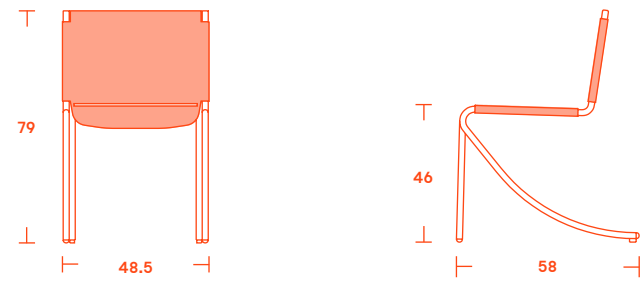

Dimensioni/Dimensions		Struttura/Frame	
Sedia/Chair	L48.5	Struttura verniciata/Painted frame	MT16
	D58	Struttura cromata/Cromed frame	MT17
	H79		
Seduta/Seat	H46		

Scocca		Finiture struttura	
Cuolo	Colore 02	(Nero)	Verniciato opaco nichel nero
	Colore 03	(Grigio scuro)	Cromato
	Colore 26	(Naturale)	
	Colore 27	(Testa di moro)	
	Colore 29	(Tortora)	
	Colore 31	(Marrone)	
	Colore 36	(Grigio foca)	

Shell finish		Frame finish	
Saddle	Color 02	(Black)	Matt painted black nickel
	Color 03	(Dark grey)	Chrome
	Color 26	(Natural)	
	Color 27	(Testa di moro)	
	Color 29	(Turtledove)	
	Color 31	(Brown)	
	Color 36	(Seal grey)	

## Judd

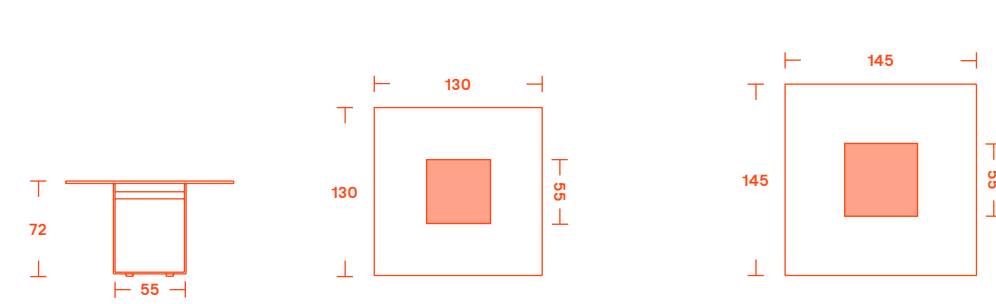

Dimensioni/Dimensions
L130 / 145
D130 / 145
H72

Dimensioni/Dimensions	
L220 / 240	
D126	
H72	

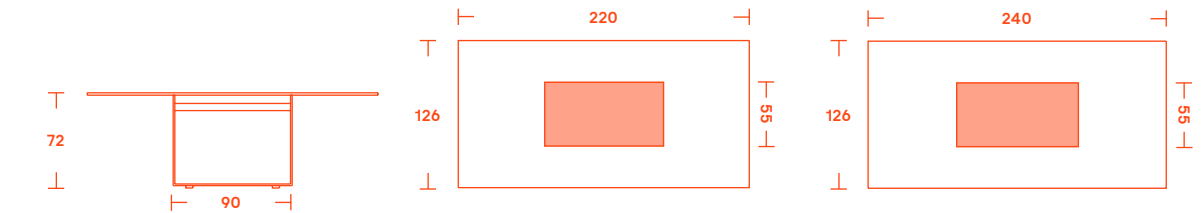

Dimensioni/Dimensions
L280
D126
H72

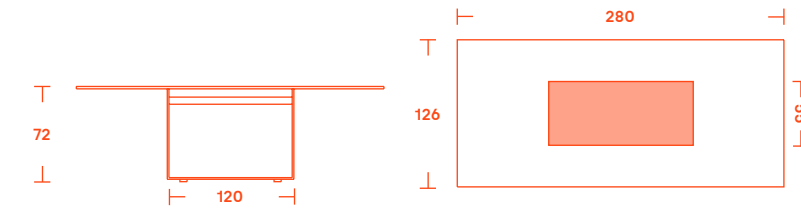

Top	Base esterna	Base interna
Cristallo trasparente	Acciaio lucido	Eucalipto nero
VT17	MT01	ES47
		Eucalipto
		ES48
		Ebano
		ES46
		Larice nero spazzolato
		ES56
		Cristallo laccato nero
		VT03
		Vetro a specchio
		VT19
		Vetro a specchio piombo
		VT20
Top	External base	Internal base
Transparent glass	Shiny steel	Black eucalyptus
VT17	MT01	ES47
		Eucalyptus
		ES48
		Ebony
		ES46
		Brushed black larch
		ES56
		Black lacquered glass
		VT03
		Mirror
		VT19
		Lead mirror
		VT20

Scocca/Shell finish	02	03	26	27
	29	31	36	
Struttura/Frame	MT16		MT17	

Base esterna / External base	VT17	MT01
Base interna / Internal base	ES46	ES47
	ES48	ES56
	VT03	VT19
		VT20

## Life sofa

### Modulo seduta/ Seat module

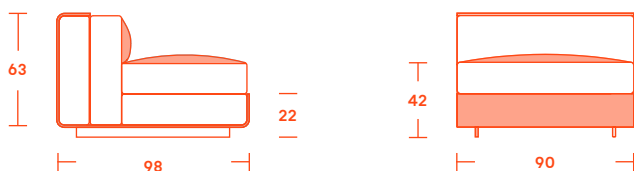

Dimensioni/Dimensions	
L90	
D98	
H63	
Seduta/Seat	H42
Tessuto/Fabric	7 x 1.40m

Struttura/Frame	
Struttura frassino/Ash frame	ES58
Struttura noce/Walnut frame	ES59
Rivestimento supplement./Add. coating	

### Pouf S / S pouf



Dimensioni/Dimensions	
L90	
D58	
H42	
Tessuto/Fabric	5 x 1.40m

Struttura/Frame	
Struttura frassino/Ash frame	ES58
Struttura noce/Walnut frame	ES59
Rivestimento supplement./Add. coating	

### Pouf M / M pouf



Dimensioni/Dimensions	
L90	
D98	
H42	
Tessuto/Fabric	6 x 1.40m

Struttura/Frame	
Struttura frassino/Ash frame	ES58
Struttura noce/Walnut frame	ES59
Rivestimento supplement./Add. coating	

### Rivestimento/Upholstery

Maia
Natura
Opera
Paradise
Sunday

## Life system

### Pannello a un contenitore / Panel with one container

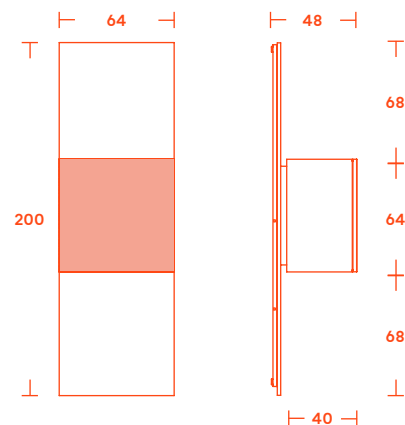

Dimensioni/Dimensions	
L64	
D48	
H200	

### Pannello a due contenitori / Panel with two containers

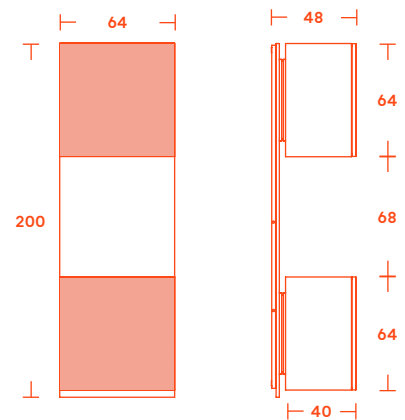

Dimensioni/Dimensions	
L64	
D48	
H200	

### Struttura

Laccato bianco opaco

LO73

### Ante

Laccato lucido bordeaux	LL20
Laccato lucido rosa	LL21
Laccato lucido verde scuro	LL22
Laccato lucido giallo senape	LL23
Laccato lucido rosso mattone	LL24
Laccato lucido argilla	LL15
Laccato lucido nero	LL06
Laccato lucido sabbia	LL12
Laccato lucido lino	LL10
Laccato lucido bianco	LL02
Laccato lucido blu navy	LL25

### Structure

Matt lacquered white

LO73

### Doors

Glossy lacquered burgundy	LL20
Glossy lacquered pink	LL21
Glossy lacquered dark green	LL22
Glossy lacquered mustard yellow	LL23
Glossy lacquered brick red	LL24
Glossy lacquered clay	LL15
Glossy lacquered black	LL06
Glossy lacquered sand	LL12
Glossy lacquered linen	LL10
Glossy lacquered white	LL02
Glossy lacquered Navy blue	LL25

NB: Il divano Life è foderabile anche con i tessuti della collezione MDF Italia (cat.B Maia; cat.D Natura; cat.E Paradise; cat.G Opera, Sunday) e/o tessuto cliente\*.

\*Fattibilità, e tempi di consegna sono da concordare e verificare con l'ufficio commerciale.

NB: The Life sofa can also be covered with fabrics from the MDF Italia collection (cat.B Maia; cat.D Natura; cat.E Paradise; cat.G Opera, Sunday) and/or customer\*own fabric.

\*Feasibility and delivery times to be verified with our Sales Dept.

Struttura/Frame	ES58	ES59
-----------------	------	------

Ante / Doors	LL20	LL21	LL22	LL23
	LL24	LL15	LL06	LL12
	LL10	LL02	LL25	
Struttura/Structure	LO73			



## Dimensioni/Dimensions

L140

D80

H30

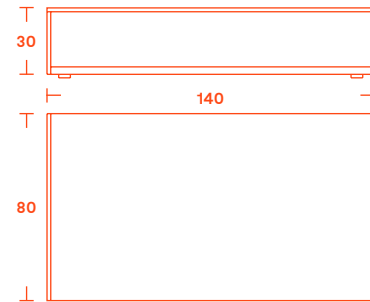

## Dimensioni/Dimensions

L110

D80

H30

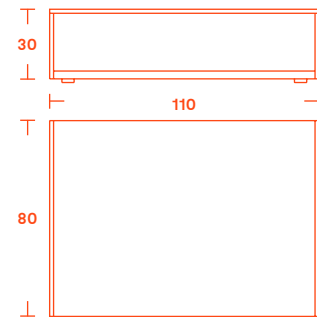

Top		Top	
	Cristallo trasparente		Transparent glass
	VT17		VT17
Base		Base	
	Acciaio lucido		Shiny steel
	MT01		MT01

Top	VT17
Base	MT01

## Dimensioni/Dimensions

L290

D55

H63

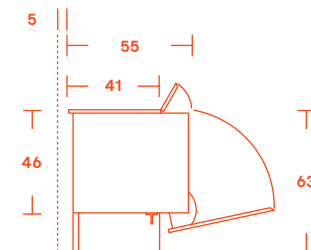
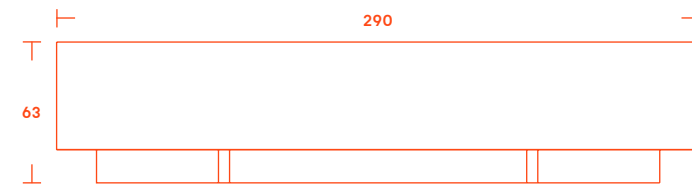

## Dimensioni/Dimensions

L220

D55

H63

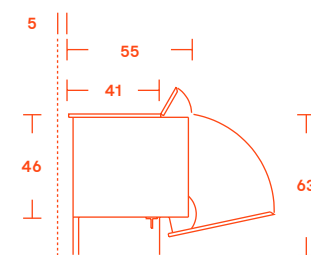
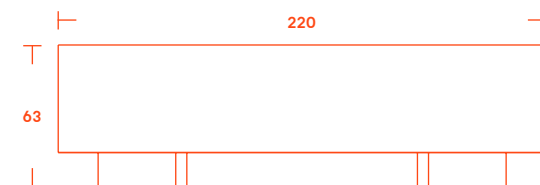

Top e anta		Top and door	
	Laccato bordeaux lucido o opaco		Glossy or matt lacquered burgundy
	LL20 / LO88		LL20 / LO88
	Laccato rosa lucido o opaco		Glossy or matt lacquered pink
	LL21 / LO89		LL21 / LO89
	Laccato verde scuro lucido o opaco		Glossy or matt lacquered dark green
	LL22 / LO90		LL22 / LO90
	Laccato giallo senape lucido o opaco		Glossy or matt lacquered mustard yellow
	LL23 / LO91		LL23 / LO91
	Laccato rosso mattone lucido o opaco		Glossy or matt lacquered brick red
	LL24 / LO92		LL24 / LO92
	Laccato bianco SW lucido o opaco		Glossy or matt lacquered SW white
	LL09 / LO74		LL09 / LO74
	Laccato argilla lucido o opaco		Glossy or matt lacquered clay
	LL15 / LO81		LL15 / LO81
	Laccato nero lucido o opaco		Glossy or matt lacquered black
	LL06 / LO72		LL06 / LO72
	Laccato sabbia lucido o opaco		Glossy or matt lacquered sand
	LL12 / LO76		LL12 / LO76
	Laccato lino lucido o opaco		Glossy or matt lacquered linen
	LL10 / LO75		LL10 / LO75
	Laccato bianco lucido o opaco		Glossy or matt lacquered white
	LL02 / LO73		LL02 / LO73
	Laccato blu navy lucido o opaco		Glossy or matt lacquered Navy blue
	LL25 / LO93		LL25 / LO93
	Eucalpto		Eucalyptus
	ES48		ES48
	Eucalpto nero		Black eucalyptus
	ES47		ES47
	Ebano		Ebany
	ES46		ES46
Fianchi		Sides	
	Acciaio lucido		Shiny steel
	MT01		MT01

Contenitore e ante/Cabinet and doors	LL20 / LO88	LL21 / LO89	LL22 / LO90	LL23 / LO91
	LL24 / LO92	LL09 / LO74	LL15 / LO81	LL06 / LO72
	LL12 / LO76	LL10 / LO75	LL02 / LO73	LL25 / LO93
	ES46	ES47	ES48	

# Maestro

Tavolo / Table 250

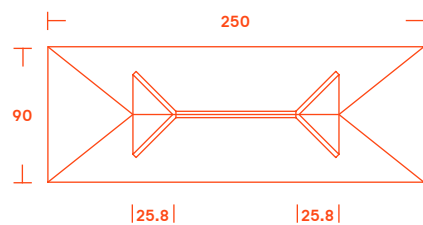
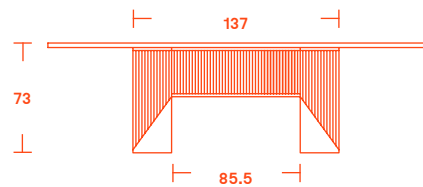

Dimensioni/Dimensions	
Top	90 x 250
H	73

Struttura/Frame	
Frassino/Ash	
Noce/Walnut	

Tavolo / Table 300

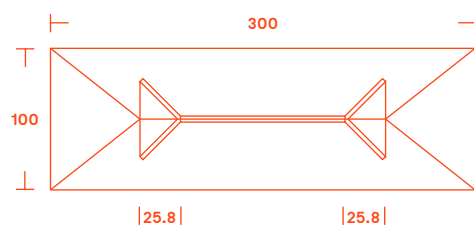
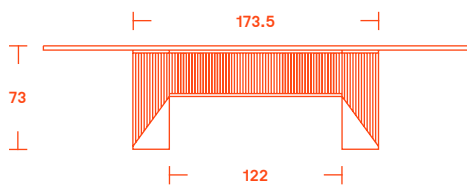

Dimensioni/Dimensions	
Top	100 x 300
H	73

Struttura/Frame	
Frassino/Ash	
Noce/Walnut	

Tavolo / Table 350

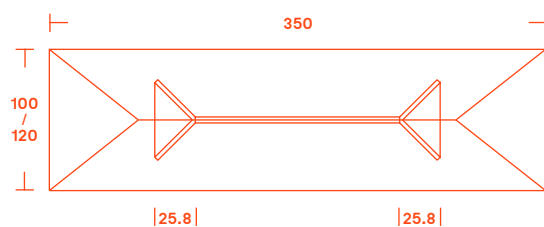
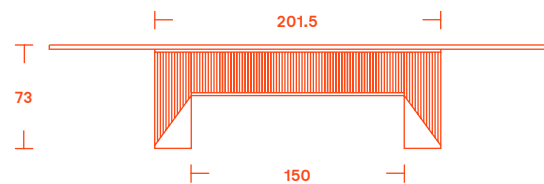

Dimensioni/Dimensions	
Top	100 x 350
	120 x 350
H	73

Struttura/Frame	
Frassino/Ash	
Noce/Walnut	

Top	Struttura
Frassino nero ES58	Frassino nero ES58
Noce tinto scuro ES59	Noce tinto scuro ES59
Top	Structure
Black ash ES58	Black ash ES58
Dark stained walnut ES59	Dark stained walnut ES59

# Maxwell

Dimensioni/Dimensions	
L	240/300
D	125
H	75

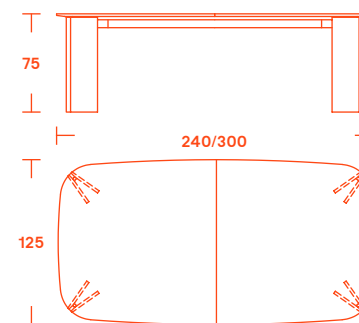

Dimensioni/Dimensions	
L	200
D	200
H	75

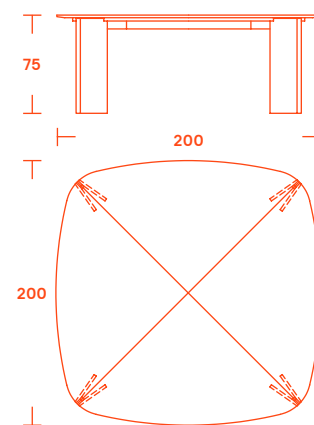

Dimensioni/Dimensions		Lazy Susan
L	180/200	L90
D	180/200	D90
H	75	H3

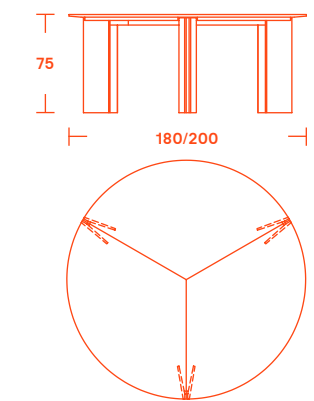

Top/Base		Top/Base	
Marmo arabescato bianco opaco MR02		White arabesque marble matt or glossy	MR02
Marmo rosso Levanto opaco MR06		Levanto red marble	MR06
Marmo verde Alpi opaco MR07		Alpi Green marble	MR07

Struttura in metallo, interno gambe e sottopiano di legno verniciato grigio ardesia.  
Metal frame, inner legs and under top wooden panel painted slate grey.  
Finitura lucida poliestere disponibile su richiesta.  
Glossy polyester finishing available on request.

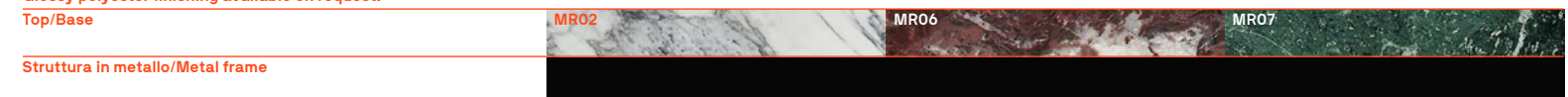

Sedia/Chair

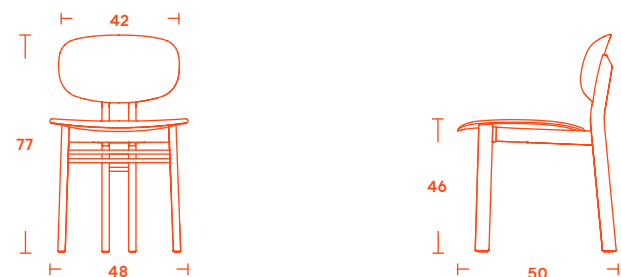

Dimensioni/Dimensions	
L48	
D50	
H77	

Struttura/Frame	
Frassino nero / Black ash	ES58
Noce tinto scuro/Dark stained walnut	ES59

Struttura/Frame	ES58	ES59

<p>Tavolino/Low table C+E</p>			<p>Dimensioni/Dimensions</p> <p>Ø80 / Ø100 / Ø120</p> <p>H36.2 / 42.5 / 48.8</p>	<p>Top</p> <p>Frassino/Ash</p> <p>Laccato/Lacquered</p> <p>Noce/Walnut</p>																																	
<p>Tavolino/Low table A</p>			<p>Dimensioni/Dimensions</p> <p>Ø80 / Ø100 / Ø120</p> <p>H36.2 / 42.5 / 48.8</p>	<p>Top</p> <p>Frassino/Ash</p> <p>Laccato/Lacquered</p> <p>Noce/Walnut</p>																																	
<p>Tavolino/Low table B+E</p>			<p>Dimensioni/Dimensions</p> <p>Ø80 / Ø100 / Ø120</p> <p>H36.2 / 42.5 / 48.8</p>	<p>Top</p> <p>Frassino/Ash</p> <p>Laccato/Lacquered</p> <p>Noce/Walnut</p>																																	
<p>Tavolino/Low table C+D</p>			<p>Dimensioni/Dimensions</p> <p>Ø80 / Ø100 / Ø120</p> <p>H36.2 / 42.5 / 48.8</p>	<p>Top</p> <p>Frassino/Ash</p> <p>Laccato/Lacquered</p> <p>Noce/Walnut</p>																																	
<p>Consolle B+E</p>		<p>Consolle A+E</p>		<p>Dimensioni/Dimensions</p> <p>L180</p> <p>D40</p> <p>H80.2</p>	<p>Top</p> <p>Frassino/Ash</p> <p>Laccato/Lacquered</p> <p>Noce/Walnut</p>																																
<p>Rocchio/Drum</p> <p>Marmo/Marble</p> <table border="1"> <tbody> <tr> <td>Carrara statuario/Carrara statuario white</td> <td>MR04</td> </tr> <tr> <td>Nero Marquinia/Marquinia black</td> <td>MR05</td> </tr> <tr> <td>Rosso Levante/Levanto red</td> <td>MR06</td> </tr> <tr> <td>Verde Alpi/Alpi green</td> <td>MR07</td> </tr> </tbody> </table>				Carrara statuario/Carrara statuario white	MR04	Nero Marquinia/Marquinia black	MR05	Rosso Levante/Levanto red	MR06	Verde Alpi/Alpi green	MR07	<p>Top</p> <p>Laccato lucido/Glossy laquered</p> <table border="1"> <tbody> <tr> <td>Bordeaux</td> <td>LL20</td> </tr> <tr> <td>Rosa/Pink</td> <td>LL21</td> </tr> <tr> <td>Verde scuro/Dark green</td> <td>LL22</td> </tr> <tr> <td>Giallo senape/Mustard yellow</td> <td>LL23</td> </tr> <tr> <td>Rosso mattone/Brick red</td> <td>LL24</td> </tr> <tr> <td>Bianco SW/White SW</td> <td>LL09</td> </tr> <tr> <td>Argilla/Clay</td> <td>LL15</td> </tr> <tr> <td>Nero/Black</td> <td>LL06</td> </tr> <tr> <td>Sabbia/Sand</td> <td>LL12</td> </tr> <tr> <td>Lino/Linen</td> <td>LL10</td> </tr> <tr> <td>Bianco/White</td> <td>LL02</td> </tr> <tr> <td>Biu navy/Navy blue</td> <td>LL25</td> </tr> </tbody> </table>		Bordeaux	LL20	Rosa/Pink	LL21	Verde scuro/Dark green	LL22	Giallo senape/Mustard yellow	LL23	Rosso mattone/Brick red	LL24	Bianco SW/White SW	LL09	Argilla/Clay	LL15	Nero/Black	LL06	Sabbia/Sand	LL12	Lino/Linen	LL10	Bianco/White	LL02	Biu navy/Navy blue	LL25
Carrara statuario/Carrara statuario white	MR04																																				
Nero Marquinia/Marquinia black	MR05																																				
Rosso Levante/Levanto red	MR06																																				
Verde Alpi/Alpi green	MR07																																				
Bordeaux	LL20																																				
Rosa/Pink	LL21																																				
Verde scuro/Dark green	LL22																																				
Giallo senape/Mustard yellow	LL23																																				
Rosso mattone/Brick red	LL24																																				
Bianco SW/White SW	LL09																																				
Argilla/Clay	LL15																																				
Nero/Black	LL06																																				
Sabbia/Sand	LL12																																				
Lino/Linen	LL10																																				
Bianco/White	LL02																																				
Biu navy/Navy blue	LL25																																				
<p>Stelo/Stand</p> <p>Verniciato opaco nero/Matt painted black</p>																																					
<p>Top</p> <p>Essenze/Essences</p> <table border="1"> <tbody> <tr> <td>Frassino nero/Black ash</td> <td>ES58</td> </tr> <tr> <td>Noce tinto scuro/Dark stained walnut</td> <td>ES59</td> </tr> </tbody> </table>						Frassino nero/Black ash	ES58	Noce tinto scuro/Dark stained walnut	ES59																												
Frassino nero/Black ash	ES58																																				
Noce tinto scuro/Dark stained walnut	ES59																																				
<p>Rocchio/Drum</p> <table border="1"> <thead> <tr> <th>A</th> <th>B</th> <th>C</th> <th>D</th> <th>E</th> </tr> </thead> <tbody> <tr> <td></td> <td></td> <td></td> <td></td> <td></td> </tr> </tbody> </table>						A	B	C	D	E																											
A	B	C	D	E																																	
<p>Top (H36.2/H42.5 LØ80, Ø100, Ø120; H48,8 LØ80, Ø100)</p> <table border="1"> <thead> <tr> <th>Ø80</th> <th>Ø100</th> <th>Ø120</th> </tr> </thead> <tbody> <tr> <td></td> <td></td> <td></td> </tr> </tbody> </table>						Ø80	Ø100	Ø120																													
Ø80	Ø100	Ø120																																			
<p>Top consolle</p>																																					
<p>Top</p> <table border="1"> <tbody> <tr> <td></td> <td></td> <td></td> <td></td> </tr> <tr> <td></td> <td></td> <td></td> <td></td> </tr> <tr> <td></td> <td></td> <td></td> <td></td> </tr> <tr> <td></td> <td colspan="2"></td> <td></td> </tr> </tbody> </table>																																					
<p>Rocchio/Drum</p> <table border="1"> <tbody> <tr> <td></td> <td></td> <td></td> <td></td> </tr> </tbody> </table>																																					
<p>Stelo/Stand</p>																																					

# Moodboard

Dimensioni/Dimensions  
L120  
D80  
H31.5/33

Dimensioni/Dimensions  
L160  
D80  
H31.5/33

Dimensioni/Dimensions  
L120  
D120  
H31.5/33

Top	Marmo arabescato bianco opaco	MR02	Base	Verniciato grigio micaceo
	Marmo grafite opaco	MR03		
	Noce tinto scuro	ES59	Base	Micaceous grey painted
	Frassino palude	ES57		

Top	White arabesque marble matt	MR02	Vassoio	Acciaio lucido	MT01
	Graphite grey marble matt	MR03		Acciaio lucido ottonato	MT03
	Dark stained walnut	ES59	Tray	Shiny steel	MT01
	Swamp ash	ES57		Satin polished steel - brass effect	MT03

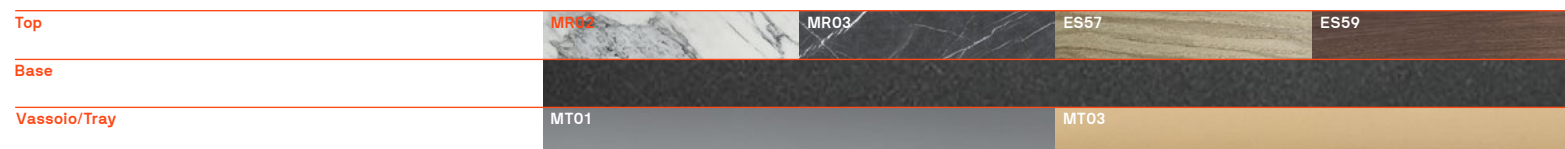

# Moodboard Console

Dimensioni/Dimensions  
L240  
D40  
H51.5

Dimensioni/Dimensions  
L240  
D40  
H51.5

Dimensioni/Dimensions  
L240  
D40  
H51.5

Dimensioni/Dimensions  
L240  
D40  
H53

Top	Marmo arabescato bianco opaco	MR02	Base	Verniciato grigio micaceo
	Marmo grafite opaco	MR03		
	Noce tinto scuro	ES59	Base	Micaceous grey painted
	Frassino palude	ES57		

Top	White arabesque marble matt	MR02	Vassoio	Acciaio lucido	MT01
	Graphite grey marble matt	MR03		Acciaio lucido ottonato	MT03
	Dark stained walnut	ES59	Tray	Shiny steel	MT01
	Swamp ash	ES57		Satin polished steel - brass effect	MT03

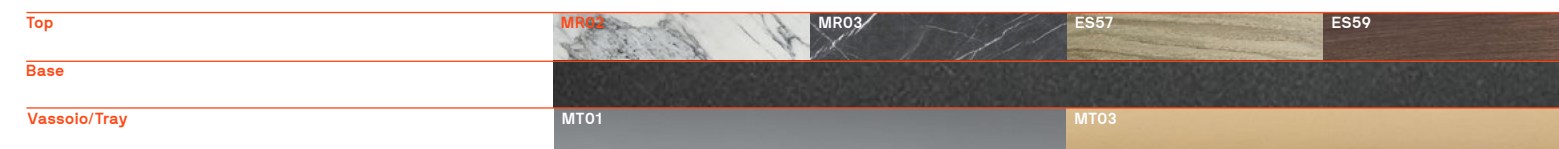

## NC Sideboard

### Dimensioni/Dimensions

L160

D60

H60

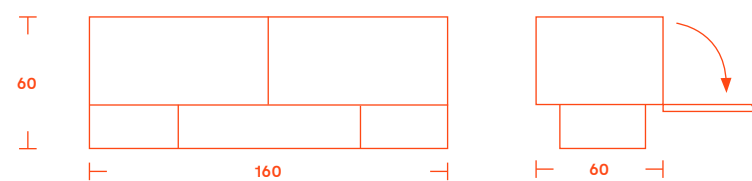

### Dimensioni/Dimensions

L240

D60

H60

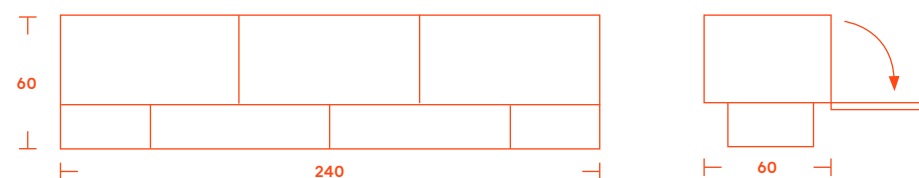

Top e anta	
Laccato lucido/opaco bianco	LL02/LO73
Laccato lucido/opaco bianco SW	LL09/LO74
Laccato lucido/opaco lino	LL10/LO75
Laccato lucido/opaco sabbia	LL12/LO76
Laccato lucido/opaco argilla	LL15/LO81
Laccato lucido/opaco giallo senape	LL23/LO91
Laccato lucido/opaco rosso mattone	LL24/LO92
Laccato lucido/opaco bordeaux	LL20/LO88
Laccato lucido/opaco rosa	LL21/LO89
Laccato lucido/opaco verde scuro	LL22/LO90
Laccato lucido/opaco blu navy	LL25/LO93
Laccato lucido/opaco nero	LL06/LO72
Eucalipto nero	ES47
Eucalipto	ES48
Noce tinto scuro	ES59

Top and doors	
Glossy/matt lacquered white	LL02/LO73
Glossy/matt lacquered SW white	LL09/LO74
Glossy/matt lacquered linen	LL10/LO75
Glossy/matt lacquered sand	LL12/LO76
Glossy/matt lacquered clay	LL15/LO81
Glossy/matt lacquered mustard yellow	LL23/LO91
Glossy/matt lacquered brick red	LL24/LO92
Glossy/matt lacquered burgundy	LL20/LO88
Glossy/matt lacquered pink	LL21/LO89
Glossy/matt lacquered dark green	LL22/LO90
Glossy/matt lacquered Navy blue	LL25/LO93
Glossy/matt lacquered black	LL06/LO72
Black eucalyptus	ES47
Eucalyptus	ES48
Dark stained walnut	ES59

Base  
Metacrilato trasparente

Base  
Transparent methacrylate

Top e anta / Top and doors	LL20 / LO88	LL21 / LO89	LL22 / LO90	LL23 / LO91
	LL24 / LO92	LL09 / LO74	LL15 / LO81	LL06 / LO72
	LL12 / LO76	LL10 / LO75	LL02 / LO73	LL25 / LO93
	ES48	ES47	ES59	

Informazioni tecniche

Technical information

## Outline

### Dimensioni/Dimensions

L108

D41

H221

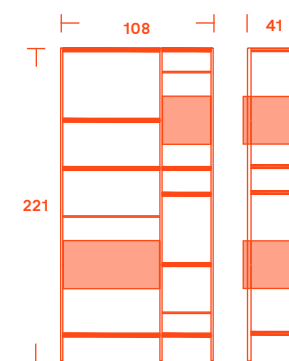

### Dimensioni/Dimensions

L144

D41

H221

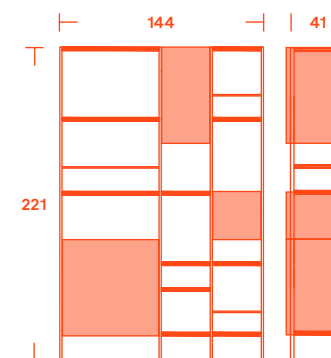

### Dimensioni/Dimensions

L178

D41

H221

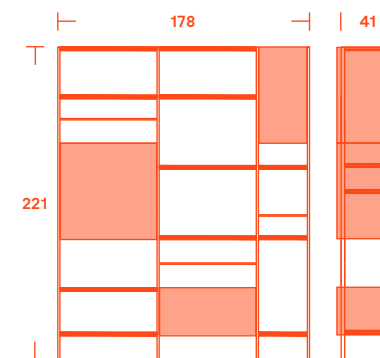

Contenitori e mensole		
Eucalipto	ES48	
Noce tinto scuro	ES59	

Shelves and cabinets		
Eucalyptus	ES48	
Dark stained walnut	ES59	

Struttura		
Acciaio satinato verniciato nichel nero	MT05	

Frame		
Satin steel - black nickel painted	MT05	

Contenitori e mensole Shelves and cabinets	ES48	ES59
Struttura/Frame	MT05	

167 Acerbis

Catalogo

# Pond

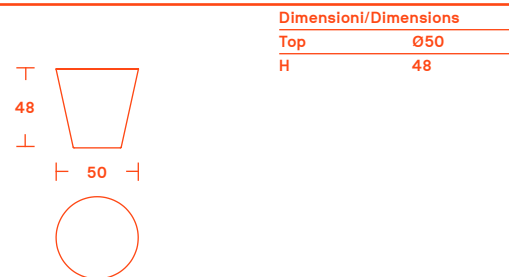

Dimensioni/Dimensions	
Top	Ø50
H	48

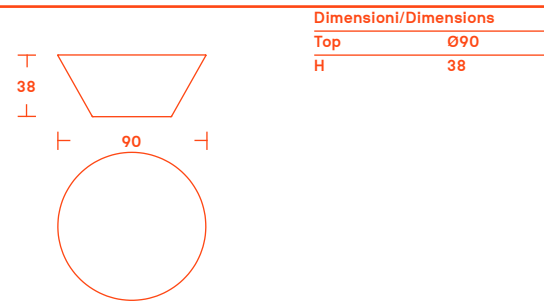

Dimensioni/Dimensions	
Top	Ø90
H	38

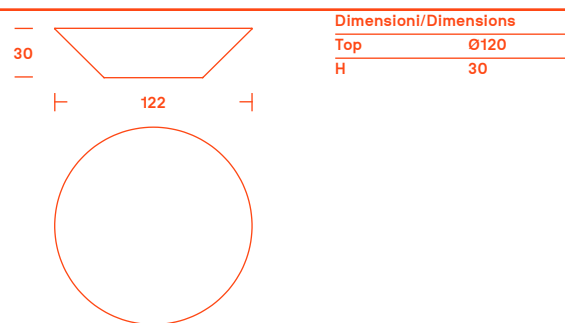

Dimensioni/Dimensions	
Top	Ø120
H	30

Top		Top	
Vetro a specchio piombo	VT20	Leaded mirror glass	VT20
Vetro a specchio	VT19	Mirror glass	VT19
Cristallo laccato bianco SW	VT12	White SW lacquered glass	VT12
Cristallo laccato lino	VT15	Linen lacquered glass	VT15
Cristallo laccato sabbia	VT14	Sand lacquered glass	VT14
Cristallo laccato argilla	VT13	Clay lacquered glass	VT13
Cristallo laccato giallo senape	VT10	Mustard yellow lacquered glass	VT10
Cristallo laccato rosso mattone	VT11	Brick red lacquered glass	VT11
Cristallo laccato bordeaux	VT07	Burgundy lacquered glass	VT07
Cristallo laccato rosa	VT08	Pink lacquered glass	VT08
Cristallo laccato verde scuro	VT09	Dark green lacquered glass	VT09
Cristallo laccato blu navy	VT16	Navy lacquered glass	VT16
Cristallo laccato nero	VT03	Black lacquered glass	VT03
Marmo Arabescato bianco opaco	MR02	White Arabesque marble matt or glossy	MR02
Marmo verde Alpi	MR07	Alpi green marble	MR07
Marmo rosso Levanto	MR06	Levanto red marble	MR06

Base		Base	
Laccato lucido bianco	LL02	White glossy lacquered	LL02
Laccato lucido bianco SW	LL09	White SW glossy lacquered	LL09
Laccato lucido lino	LL10	Linen glossy lacquered	LL10
Laccato lucido sabbia	LL12	Sand glossy lacquered	LL12
Laccato lucido argilla	LL15	Clay glossy lacquered	LL15
Laccato lucido giallo senape	LL23	Mustard yellow glossy lacquered	LL23
Laccato lucido rosso mattone	LL24	Brick red glossy lacquered	LL24
Laccato lucido bordeaux	LL20	Burgundy glossy lacquered	LL20
Laccato lucido rosa	LL21	Pink glossy lacquered	LL21
Laccato lucido verde scuro	LL22	Dark green glossy lacquered	LL22
Laccato lucido blu navy	LL25	Navy blue glossy lacquered	LL25
Laccato lucido nero	LL06	Black glossy lacquered	LL06

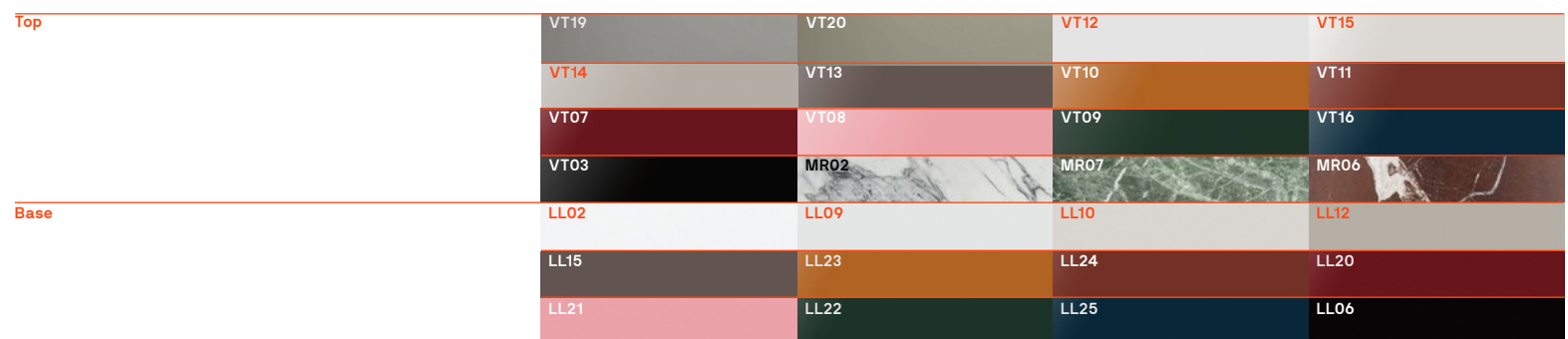

Informazioni tecniche

Technical information

# Serenissimo

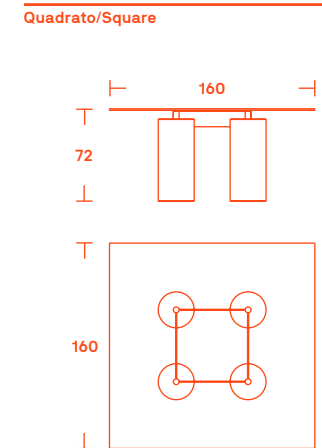

Dimensioni/Dimensions	
Top	160x160
H	72

Top		Base	
Cristallo/Glass		Verniciato/Painted	
Vetro/Glass		Encausto/Encaustic	
Verniciato/Painted			

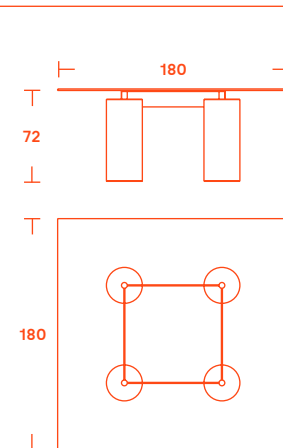

Dimensioni/Dimensions	
Top	180x180
H	72

Top		Base	
Cristallo/Glass		Verniciato/Painted	
Vetro/Glass		Encausto/Encaustic	
Verniciato/Painted			

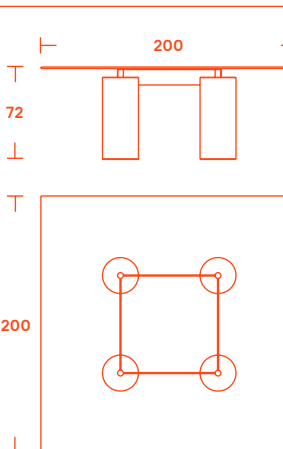

Dimensioni/Dimensions	
Top	200x200
H	72

Top		Base	
Cristallo/Glass		Verniciato/Painted	
Vetro/Glass		Encausto/Encaustic	
Verniciato/Painted			

Top		Base	
Cristallo trasparente	VT17	Verniciato opaco bronzo orbitale	MT14
Cristallo opalescente extrachiaro	VT05	Verniciato opaco canna di fucile	MT13
Vetro nero colato	VT18	Encausto bianco	EN01
		Encausto verde	EN02
		Encausto terracotta	EN03

Telaio/Frame Verniciato grigio micaceo

Top		Base	
Transparent glass	VT17	Matt painted orbital bronze	MT14
Extraclear opalescent glass	VT05	Matt painted gunmetal	MT13
Black cast glass	VT18	White encaustic	EN01
		Green encaustic	EN02
		Terracotta encaustic	EN03

Telaio/Frame Micaceous grey painted

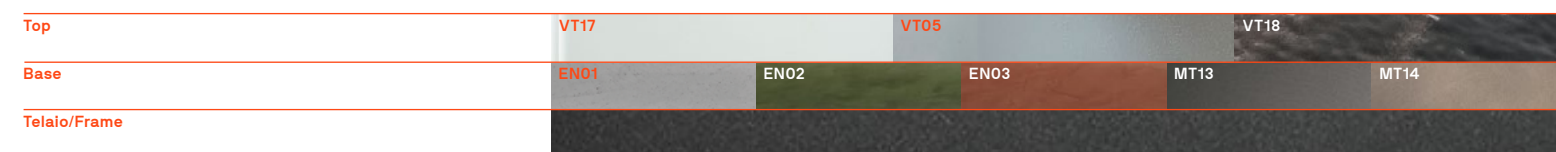

169 Acerbis

Catalogo

# Serenissimo

Rettagonolare/Rectangular

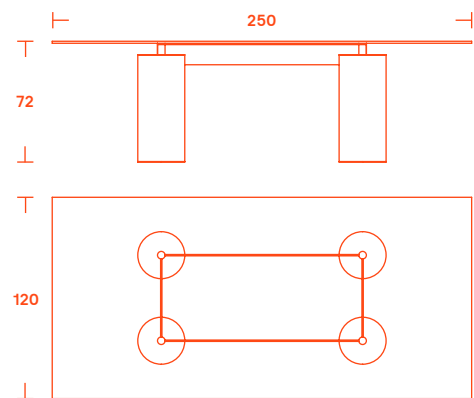

Dimensioni/Dimensions

Top 250x120  
H72

Top

Cristallo/Glass  
Vetro/Glass

Base

Verniciato/Painted  
Encausto/Encaustic

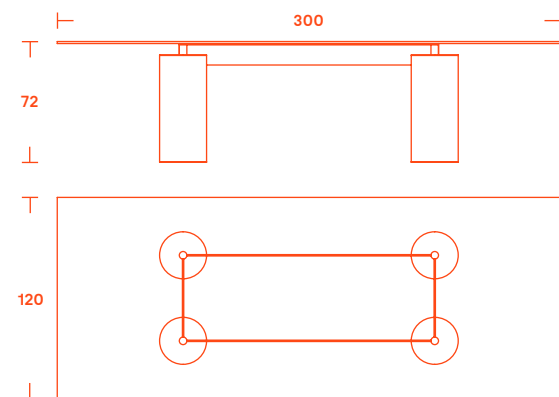

Dimensioni/Dimensions

Top 300x120  
H72

Top

Cristallo/Glass  
Vetro/Glass

Base

Verniciato/Painted  
Encausto/Encaustic

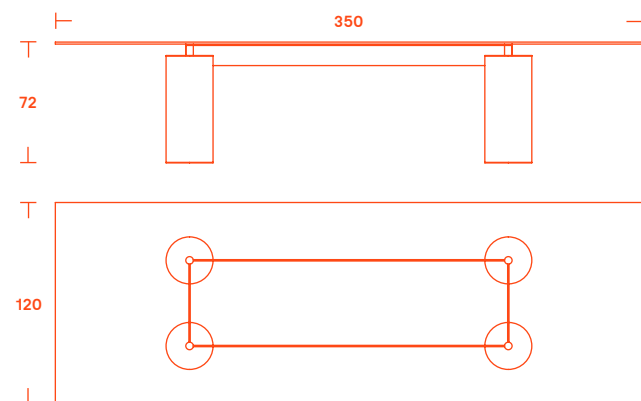

Dimensioni/Dimensions

Top 350x120  
H72

Top

Cristallo/Glass  
Vetro/Glass

Base

Verniciato/Painted  
Encausto/Encaustic

Top	Base
Cristallo trasparente VT17	Verniciato opaco bronzo orbitale MT14
Cristallo opalescente extrachiaro VT05	Verniciato opaco canna di fucile MT13
Vetro nero colato* VT18	Encausto bianco EN01
	Encausto verde EN02
	Encausto terracotta EN03

Telaio/Frame
Verniciato grigio micaceo

Top	Base
Extraclear glass VT17	Matt painted orbital bronze MT14
Extraclear opalescent glass VT05	Matt painted gunmetal MT13
Black cast glass* VT18	White encaustic EN01
	Green encaustic EN02
	Terracotta encaustic EN03

Telaio/Frame
Micaceous grey painted

\*Non disponibile L350 cm.  
\*Not available L350 cm.

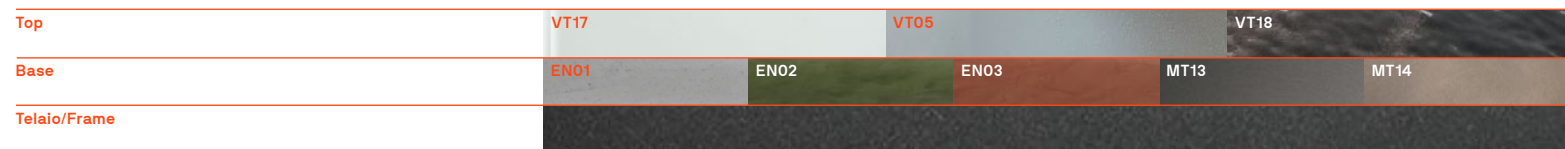

# Sheraton

Dimensioni/Dimensions

D280  
D49  
H70

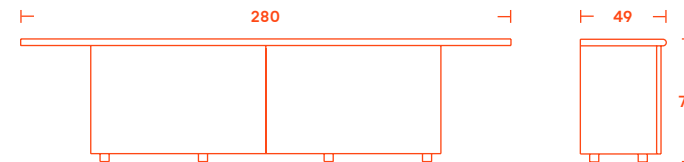

\*disponibile con o senza luce interna. / \* available with or without internal light.

Cassetto	Finiture ante e top
Noce tinto scuro ES59	Laccato lucido bordeaux LL20
	Laccato lucido rosa LL21
	Laccato lucido verde scuro LL22
	Laccato lucido giallo senape LL23
	Laccato lucido rosso mattone LL24
	Laccato lucido bianco SW LL09
	Laccato lucido argilla LL15
	Laccato lucido nero LL06
	Laccato lucido sabbia LL12
	Laccato lucido lino LL10
	Laccato lucido bianco LL02
	Laccato lucido blu navy LL25

Drawer	Doors and top finish
Dark stained walnut ES59	Glossy lacquered burgundy LL20
	Glossy lacquered pink LL21
	Glossy lacquered dark green LL22
	Glossy lacquered mustard yellow LL23
	Glossy lacquered brick red LL24
	Glossy lacquered SW white LL09
	Glossy lacquered clay LL15
	Glossy lacquered black LL06
	Glossy lacquered sand LL12
	Glossy lacquered linen LL10
	Glossy lacquered white LL02
	Glossy lacquered Navy blue LL25

\*Corpo del mobile laccato opaco, nello stesso colore degli esterni. Cassetto in essenza di Noce tinto scuro; 3 ripiani in vetro trasparente. Sono disponibili cassetti interni aggiuntivi per il vano centrale.  
\*Case in matt lacquer, in the same colour as the exterior. Drawer in veneer dark stained walnut; 3 transparent glass shelves. The central compartment has room for additional internal drawers.

Finiture anta e top/Doors and top finishes	LL20	LL21	LL22	LL23
	LL24	LL09	LL15	LL06
	LL12	LL10	LL02	LL25
Cassetto/Drawer	ES59			

# Spiros

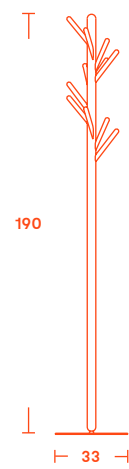

Dimensioni/Dimensions  
D33  
H190

Struttura/Frame  
Frassino/Ash

## Finitura

Frassino tinto nero ES60  
Frassino naturale ES61

## Finish

Black stained ash ES60  
Natural ash ES61



# Steel

Dimensioni/Dimensions  
L163  
D64  
H72

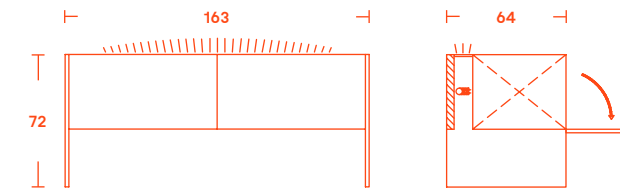

Dimensioni/Dimensions  
L243  
D64  
H72

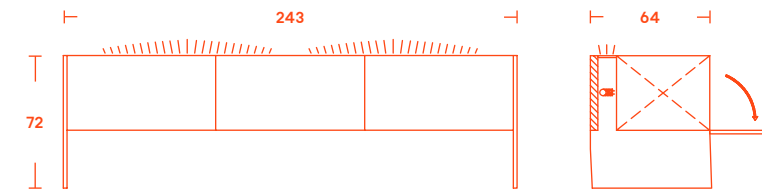

## Top e anta

Laccato lucido/opaco bianco LL02/LO73  
Laccato lucido/opaco bianco SW LL09/LO74  
Laccato lucido/opaco lino LL10/LO75  
Laccato lucido/opaco sabbia LL12/LO76  
Laccato lucido/opaco argilla LL15/LO81  
Laccato lucido/opaco giallo senape LL23/LO91  
Laccato lucido/opaco rosso mattone LL24/LO92  
Laccato lucido/opaco bordeaux LL20/LO88  
Laccato lucido/opaco rosa LL21/LO89  
Laccato lucido/opaco verde scuro LL22/LO90  
Laccato lucido/opaco blu navy LL25/LO93  
Laccato lucido/opaco nero LL06/LO72  
Eucalpto nero ES47  
Eucalpto ES48  
Noce tinto scuro ES59

## Top and doors

Glossy/matt lacquered white LL02/LO73  
Glossy/matt lacquered SW white LL09/LO74  
Glossy/matt lacquered linen LL10/LO75  
Glossy/matt lacquered sand LL12/LO76  
Glossy/matt lacquered clay LL15/LO81  
Glossy/matt lacquered mustard yellow LL23/LO91  
Glossy/matt lacquered brick red LL24/LO92  
Glossy/matt lacquered burgundy LL20/LO88  
Glossy/matt lacquered pink LL21/LO89  
Glossy/matt lacquered dark green LL22/LO90  
Glossy/matt lacquered Navy blue LL25/LO93  
Glossy/matt lacquered black LL06/LO72  
Black eucalyptus ES47  
Eucalyptus ES48  
Dark stained walnut ES59

## Finachi

Acciaio lucido

MT01

## Sides

Shiny steel

MT01

Top e anta / Top and doors	LL20 / LO88	LL21 / LO89	LL22 / LO90	LL23 / LO91
	LL24 / LO92	LL09 / LO74	LL15 / LO81	LL06 / LO72
	LL12 / LO76	LL10 / LO75	LL02 / LO73	LL25 / LO93
Finachi / Sides	ES48	ES47	ES59	
	MT01			



# Storet

## Settimanale/High chest of drawers

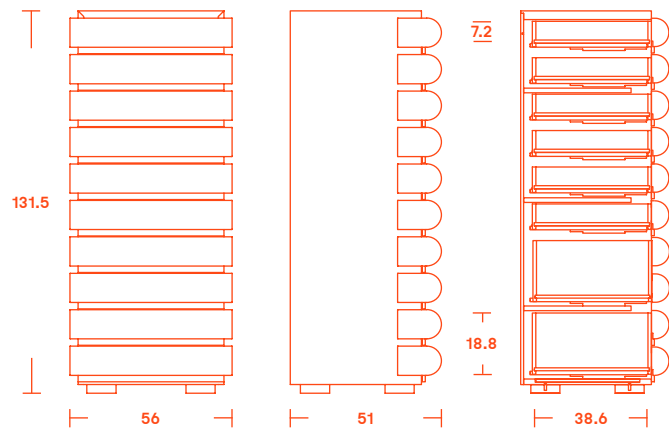

Dimensioni/Dimensions  
L56  
D51  
H131.5

Struttura/Frame  
Frassino/Ash  
Noce/Walnut

## Cassettiera/Low chest of drawers

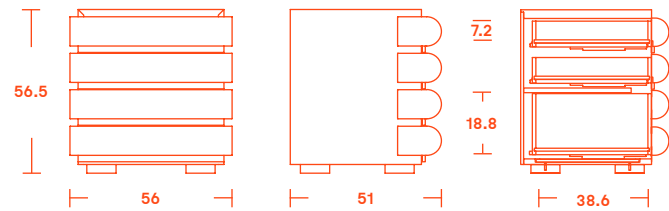

Dimensioni/Dimensions  
L56  
D51  
H56.5

Struttura/Frame  
Frassino/Ash  
Noce/Walnut

### Struttura (interno cassetto)

Frassino nero	ES58
Noce tinto scuro	ES59

### Cassetti frontali

Laccato lucido bordeaux	LL20
Laccato lucido rosa	LL21
Laccato lucido verde scuro	LL22
Laccato lucido giallo senape	LL23
Laccato lucido rosso mattone	LL24
Laccato lucido bianco SW	LL09
Laccato lucido argilla	LL15
Laccato lucido nero	LL06
Laccato lucido sabbia	LL12
Laccato lucido lino	LL10
Laccato lucido bianco	LL02
Laccato lucido blu navy	LL25

### Structure (inside drawer)

Black ash	ES58
Dark stained walnut	ES59

### Front drawers

Glossy lacquered burgundy	LL20
Glossy lacquered pink	LL21
Glossy lacquered dark green	LL22
Glossy lacquered mustard yellow	LL23
Glossy lacquered brick red	LL24
Glossy lacquered SW white	LL09
Glossy lacquered clay	LL15
Glossy lacquered black	LL06
Glossy lacquered sand	LL12
Glossy lacquered linen	LL10
Glossy lacquered white	LL02
Glossy lacquered Navy blue	LL25

Finitura cassetti frontali/ Front drawers finishes	LL20	LL21	LL22	LL23
	LL24	LL09	LL15	LL06
	LL12	LL10	LL02	LL25
Finiture struttura/Structure finishes	ES58		ES59	

Scopri la collezione  
Discover the collection



Art Direction & Design  
Francesco Meda, David Lopez Quincoces

Photos  
Alberto Strada, Alessandro Oliva,  
Lorenzo Cappellini Baio, Piotr Niepsuj

Graphic Concept  
Studio Temp

Copy & Communication  
Laura Rysman, MDF Italia marketing dept.

Made and Printed in Italy  
by Navapress srl Milan, Italy  
2022 June

M920099-0836

p.8 Lodovico Acerbis  
Courtesy Archivio Acerbis  
Photo Sheraton © Aldo Ballo  
Photo portrait © Pietro Carrieri

p.9 Gianfranco Frattini  
Courtesy Gianfranco Frattini Studio

p.10 Vico Magistretti  
Courtesy Fondazione Vico Magistretti  
Photo Florian © Aldo Ballo

p.12 Roberto Monsani  
Photo showroom Ferragamo  
Domus n° 546 del 1975

p.13 Giotto Stoppino  
Photo portrait © Aldo Ballo

p. 14 Nanda Vigo  
Courtesy Archivio Nanda Vigo  
Photo © Aldo Ballo

p16. Lella & Massimo Vignelli  
Courtesy Vignelli Center for Design Studies,  
Rochester Institute of Technology  
Photo portrait © Luca Vignelli

© Copyright 2022 MDF Italia srl Società Unipersonale all rights reserved  
MDF Italia reserves the right to change, at any time and without prior warning,  
the technical specifications of any product illustrated in this catalogue

